

## Outline

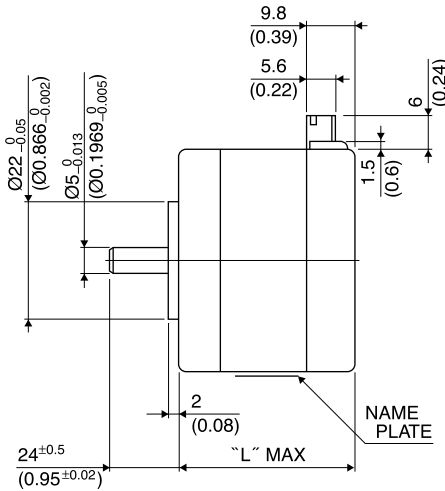
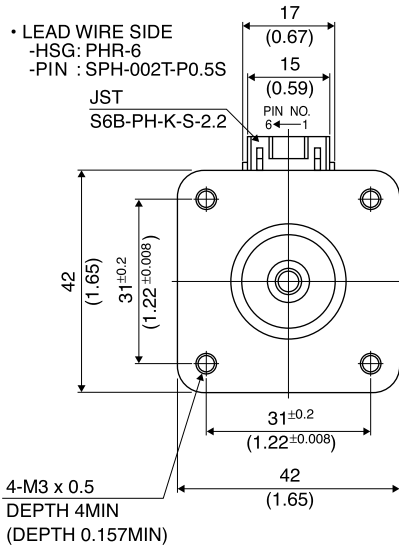

Hybrid

UNIT: mm  
(inch)

	"L"
17PY-Z7**	26 (1.02)
17PY-Z2**	30 (1.18)
17PY-Z0**	34 (1.34)
17PY-Z3**	38 (1.50)
17PY-Z1**	42 (1.65)
17PY-Z4**	48 (1.89)

PIN NO. vs. PHASE

PHASE	A	A COM	$\bar{A}$	B	B COM	$\bar{B}$
PIN NO.	4	5	6	3	2	1

## Specifications

Model	Step Angle (deg)	Drive Sequence	Rated Current (A)	Resistance (Ohms)	Holding Torque (mNm)	Inductance (mH)	Rotor Inertia (g·cm <sup>2</sup> )	Detent Torque (mNm)	Mass (g)
17PY-Z049U	0.9	UNI-POLAR	1	3.1	220	4.4	37	11.0	200
17PY-Z064U	0.9	UNI-POLAR	0.6	8.3	220	11.1	37	11.0	200
17PY-Z142U	0.9	UNI-POLAR	1.4	2.3	300	4.7	62	11.8	300
17PY-Z149U	0.9	UNI-POLAR	1	4.3	300	8.7	62	11.8	300
17PY-Z249U	0.9	UNI-POLAR	0.8	2.7	120	3.8	24	4.4	180
17PY-Z264U	0.9	UNI-POLAR	0.6	6.9	120	2.5	24	4.4	180
17PY-Z342U	0.9	UNI-POLAR	1.4	2.0	280	3.5	50	12.0	250
17PY-Z349U	0.9	UNI-POLAR	1	3.6	280	6.5	50	12.0	250
17PY-Z442U	0.9	UNI-POLAR	1.4	2.8	450	4.5	75	18.7	350
17PY-Z449U	0.9	UNI-POLAR	1	4.9	450	8.4	75	18.7	350
17PY-Z749U	0.9	UNI-POLAR	0.9	2.2	48	1.9	11	3.0	150
17PY-Z764U	0.9	UNI-POLAR	0.6	5.6	48	1.2	11	3.0	150
17PY-Z049B	0.9	BI-POLAR	0.7	6.2	270	17.5	37	11.0	200
17PY-Z142B	0.9	BI-POLAR	1	4.6	390	18.6	62	11.8	300
17PY-Z249B	0.9	BI-POLAR	0.6	5.4	160	15.2	24	4.4	180
17PY-Z342B	0.9	BI-POLAR	0.9	4.0	340	13.8	50	12.0	250
17PY-Z442B	0.9	BI-POLAR	0.9	5.6	540	18.0	75	18.7	350
17PY-Z749B	0.9	BI-POLAR	0.6	4.4	63	7.8	11	3.0	150

## Torque/Speed Characteristics

Model No: 17PY-Z049U,Z064U,Z049B  
 Driver: Chopper Dual  
 Supply Voltage: 24.0 (Volt)

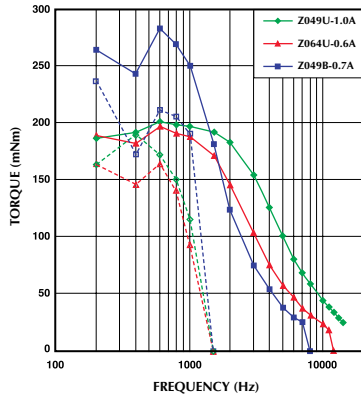

Model No: 17PY-Z142U,Z149U,Z142B  
 Driver: Chopper Dual  
 Supply Voltage: 24.0 (Volt)

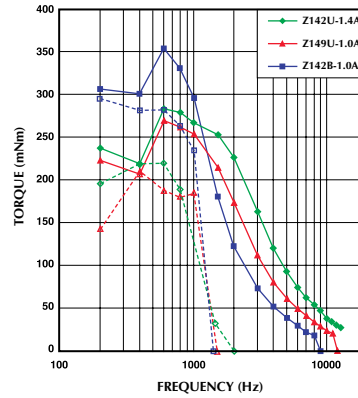

Model No: 17PY-Z249U,Z264U,Z249B  
 Driver: Chopper Dual  
 Supply Voltage: 24.0 (Volt)

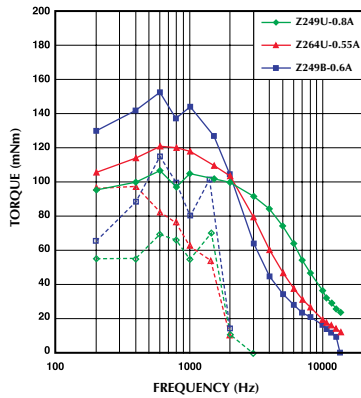

Model No: 17PY-Z342U,Z349U,Z342B  
 Driver: Chopper Dual  
 Supply Voltage: 24.0 (Volt)

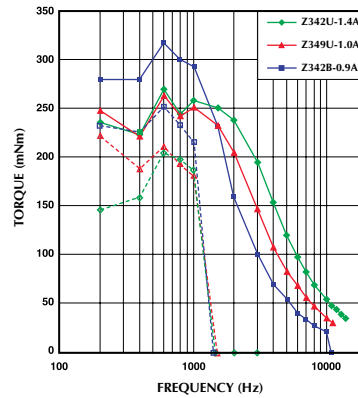

Model No: 17PY-Z442U,Z449U,Z442B  
 Driver: Chopper Dual  
 Supply Voltage: 24.0 (Volt)

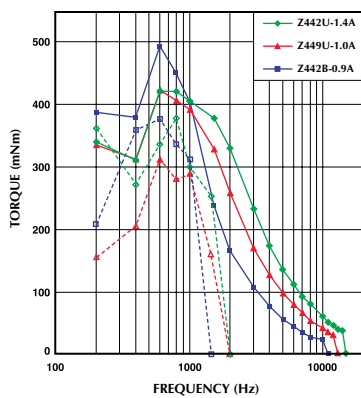

Model No: 17PY-Z749U,Z764U,Z749B  
 Driver: Chopper Dual  
 Supply Voltage: 24.0 (Volt)

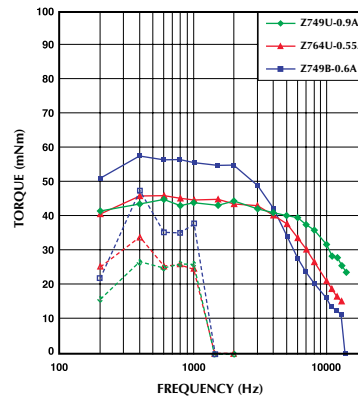

— : PULL OUT  
 - - - : PULL IN