

Outline

Encoder

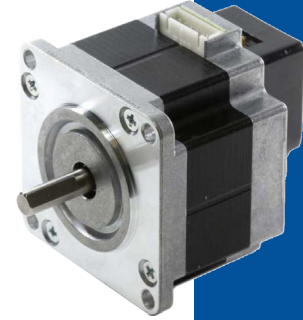
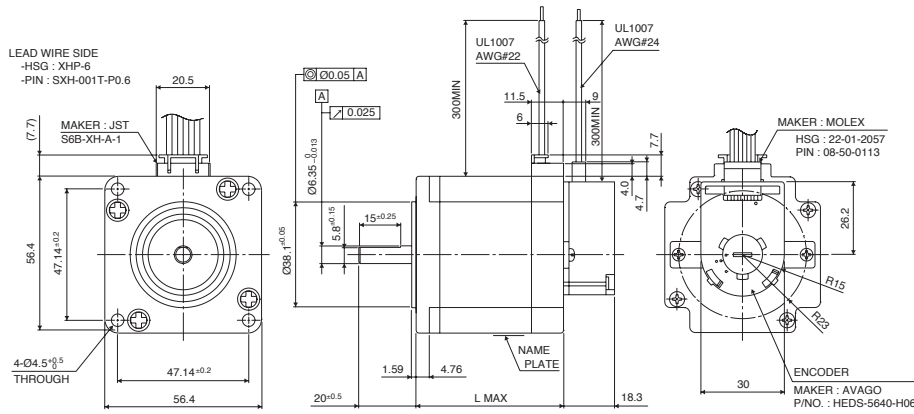

Hybrid

General Specifications

Step Accuracy: ±5%
 Temperature Rise: 80°C MAX
 Ambient Temperature Range: -10 °C ~ +50 °C
 Insulation Resistance: 100MΩ MIN. DC500V
 Dielectric Strength: AC500V 1min
 Radial Play: 20µm MAX. (at 4.4N {450gf} [Load])
 End Play: 80µm MAX. (at 4.4N {450gf} [Load])

PIN NO.	PARAMETER	L/W COLOR
1	GROUND	BLK
2	CH. I	BLU
3	CH. A	WHT
4	Vcc	RED
5	CH. B	BRN

	"L"
A23KMK2	42 (1.65)
A23KMK0	54 (2.13)
A23KMK7	76 (2.99)

Specifications

Model	Motor Size (mm)	Step Angle (deg)	Rated Current (A)	Resistance (Ohms)	Holding Torque (mNm)	Inductance (mH)	Rotor Inertia (g·cm ²)	Dentent Torque (mNm)	Mass (g)
A23KMK267-00V	□ 56 x 42	1.8	0.9	5.8	480	8.2	120	20	490
A23KMK251-00V	□ 56 x 42	1.8	1.8	1.5	480	2.4	120	20	490
A23KMK244-00V	□ 56 x 42	1.8	2.9	0.6	480	0.9	120	20	490
A23KMK066-00V	□ 56 x 54	1.8	1	7	760	15.1	200	34	700
A23KMK049-00V	□ 56 x 54	1.8	2	1.8	760	3.6	200	34	700
A23KMK044-00V	□ 56 x 54	1.8	3	0.85	760	1.8	200	34	700
A23KMK762-00V	□ 56 x 76	1.8	1	8.6	1400	17.3	360	50	1070
A23KMK748-00V	□ 56 x 76	1.8	2	2.3	1400	5.0	360	50	1070
A23KMK743-00V	□ 56 x 76	1.8	3	1.1	1400	2.2	360	50	1070

*Drive Sequence: Unipolar

*Leadwires are supplied with the motor

Specifications

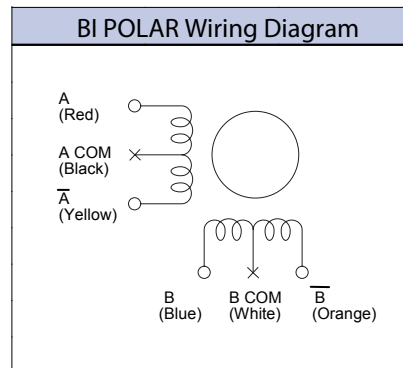
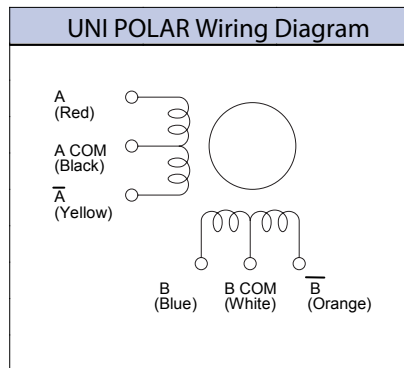

* Do not connect A COM and B COM. Please insulate individually.
 * Apply 70% of Unipolar rated current.

Encoder Specifications

Note: Use the motor within the encoder specifications.

Encoder by Avago Technologies Limited: For frame size 42 mm (17PM), HEDS- 5540-H 14 is used. Encoders are 3 channel and 400 CPR.

Absolute Maximum Ratings				
Parameter	Symbol	Min.	Max.	Notes
Supply Voltage (V)	Vcc	-0.5	7	-
Output Voltage (V)	Vo	-0.5	Vcc	-
Output Current Per Channel	Iout	-1.0	5	-
Vibration (Hz)	-	5	1000	20g
Velocity (rpm)	-	-	30000	-
Acceleration (rad/sec ²)	-	-	250000	-

Encoder Characteristics*				
Description	Symbol	Min.	Typ.**	Max.
Pulse Width Error (°e)	ΔP	-	5	45
Logic State Width Error (°e)	ΔS	-	5	35
Phase Error (°e)	$\Delta \emptyset$	-	2	15
Position Error (arc min.)	$\Delta \theta$	-	10	40
Cycle Error (°e)	ΔC	-	3	5.5
Index Pulse Width (°e)	Po	55	90	125
CH.I rise after CH.A or CH.B fall (ns) [-40° ~ +100 °C]	t1	-300	100	250
CH.I fall after CH.A or CH.B rise (ns) [-40° ~ +100 °C]	t2	70	150	1000

*The following characteristics assume that the encoder is operated under the recommended operating conditions. Each characteristic value indicates the value within one rotation of the code wheel.

**Typical values specified at Vcc = 5.0 V and 25 °C

Electrical Interface

It is recommended that the CH.A, CH.B and CH.I outputs be pulled up with a resistor of 2.7k Ω ($\pm 0\%$) in order to shorten the rise time of the output pulse. To reduce electrical noise it is recommended that a capacitor be added across Vcc-GND. For best results the capacitor should be placed as close to Vcc as possible. The capacitor's value should be adjusted to determine an acceptable level of noise.

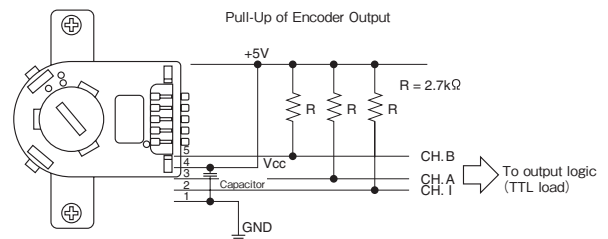

Output Waveforms

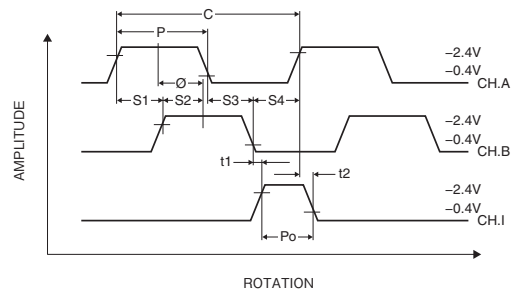

Encoder Specifications

Recommended Operating Conditions					
Parameter	Symbol	Min.	Typ.	Max.	Notes
Supply Voltage (V)	Vcc	4.5	5.0	5.5	Ripple < 100mVp-p
Load Capacitance (pF)	CL	-	-	100	2.7kΩ pull-up
Count Frequency (kHz)	f	-	-	100	Velocity (rpm) x (N/60)

The encoder specifications are designed to guarantee operation based on a response frequency of 100kHz

Recommended Connector	
Manufacturer	Part Number
Molex	2695 series (housing) 0022012051 (5pin)/0022012057 (5pin/lock type) 2759 series (pins) 0008500113

Electrical Characteristics*					
Parameter	Symbol	Min.	Typ.**	Max.	Notes
Supply Current (mA)	Icc	30	57	85	
High Level Output Voltage (V)	VOH	2.4	-	-	IOH = -200μA max
Low Level Output Voltage (V)	VOL	-	-	0.4	IOL = 3.86 mA
Rise Time (ns)	tr	-	180	-	CL = 25 pF
Fall Time (ns)	tf	-	40	-	RL = 2.7kΩ

*Electrical characteristic over recommended operating range

**Typical Values specified at Vcc = 5.0V and 25°C

Torque/Speed Characteristics

Model No : 23KM-K267, K251, K244, K066, K049, K044, K762, K748, K743
 Driver : Chopper Dual
 Supply Voltage : 24 V (DC)

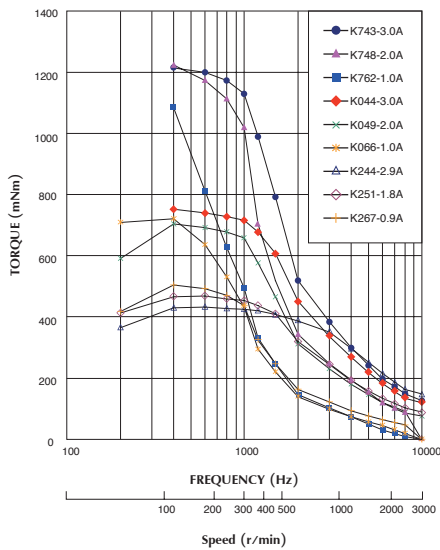

■ Definition of Key Terms

- CPR: Count Per Revolution. Resolution for rotary type encoder. Number of pulses for one revolution.
- One Cycle: 360 electrical degrees (°e) , 1 bar and window pair.
- One Shaft Rotation: 360 mechanical degrees, N cycles. One rotation of the codewheel.
- Position Error ($\Delta\theta$) : The normalized angular difference between the actual shaft position and the position indicated by the encoder cycle count.
- Cycle Error (ΔC): An indication of cycle uniformity. The difference between an observed shaft angle which gives rise to one electrical cycle, and nominal angular increment of 1/N of a revolution.
- Pulse Width (P): The number of electrical degrees that an output is high during 1 cycle. This value is nominally 180°e of 1/2 cycle.
- Pulse Width Error (ΔP): The deviation, in electrical degrees, of the pulse width from its ideal value of 180°e.
- Logic State Width (S1 ~ S4): The number of electrical degrees between a transition in the output of channel A and the neighboring transition in the output of channel B. There are 4 states per cycle, each nominally 90°e.
- Logic State Width Error (ΔS): The deviation, in electrical degrees, of each state width from its ideal value of 90°e.
- Phase (\emptyset): The number of electrical degrees between the center of the high state of channel A and the center of the high state of channel B. This value is nominally 90°e for quadrature output.
- Phase Error ($\Delta\emptyset$): The deviation of the phase from its ideal value of 90°e.
- Direction of Rotation: When the codewheel rotates in the counterclockwise direction (as viewed from the encoder end of the motor), channel A will lead channel B. If the codewheel rotates in the clockwise direction, channel B will lead channel A.
- Index Pulse Width (Po): The number of electrical degrees that an index output is high during one full shaft rotation. This value is nominally 90°e or 1/4 cycle.