

Outline

High Speed

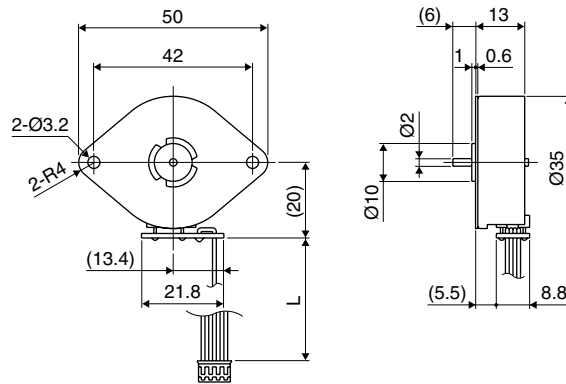

PM

*Please contact our sales for inventory and lot information. Specification may be changed without notice.

Specifications

Number of Steps per Rotation	Drive Method	Drive Circuit	Drive Voltage	Current/Phase	Coil Resistance/Phase	Drive IC
48 (7.5°/Step)	2-2 Phase	Bipolar Const. Curr.	24 [V]	500 [mA]	8.7 [Ω]	MTD2003

Magnet Material	Insulation Resistance	Dielectric Strength	Class of Insulation	Operating Temperature	Storage Temperature	Operating Humidity
Nd-Fe-B bonded magnet (N51)	100M [Ω] MIN	AC 500 [V] 1 [min]	CLASS E (except lead wire)	-10 [°C] ~ 50 [°C]	-30 [°C] ~ 80 [°C]	5 [%] RH ~ 90 [%] RH

*Bipolar only. Unipolar is not available.

Torque/Speed Characteristics

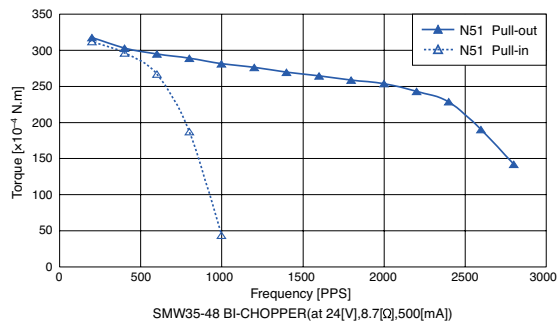

These torque values are reference only. Heat radiation conditions and temperature rise effect by duty are different on each equipment, therefore please select motors after considering the actual equipment.

Applications

- OA Equipment: Printers/Scanners