

# 42 □ 1.8°

# 17PM-K

# 1.8°

## ■ 外観図 Outline

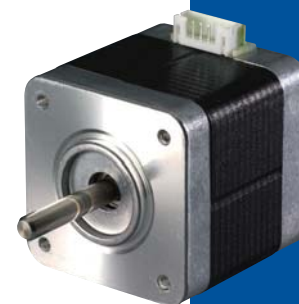
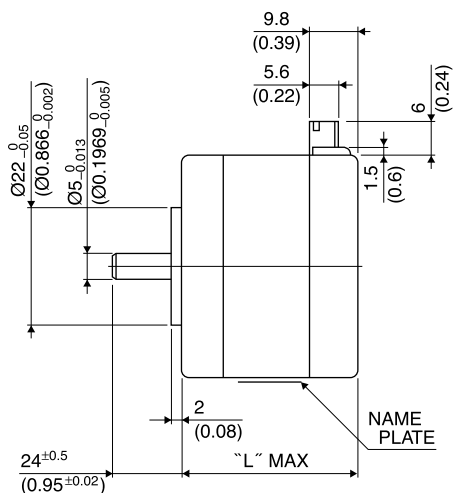
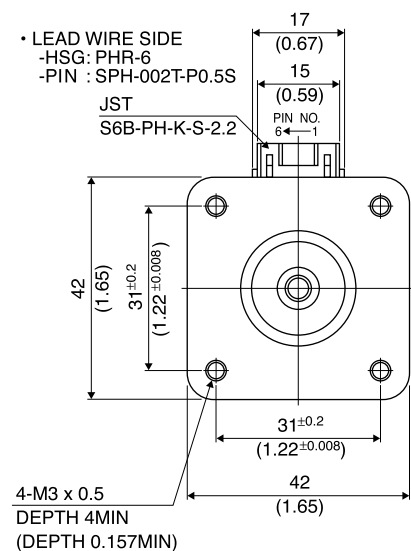

Hybrid

UNIT: mm (inch)

	"L"
17PM-K7**	26 (1.02)
17PM-K2**	30 (1.18)
17PM-K0**	34 (1.34)
17PM-K3**	38 (1.50)
17PM-K1**	42 (1.65)
17PM-K4**	48 (1.89)
17PM-KA**	60 (2.36)

結線表 PIN NO. vs. PHASE

相 (PHASE)	A	A COM	$\bar{A}$	B	B COM	$\bar{B}$
ピン番号 (PIN NO.)	4	5	6	3	2	1

## ■ 仕様 Specifications

型式	ステップ角	ドライブ方式	定格電流	巻線抵抗	ホールディングトルク	インダクタンス	ロータイナーシャ	ディテントトルク	質量
Model	Step Angle	Drive Sequence	Rated Current	Resistance	Holding Torque	Inductance	Rotor Inertia	Detent Torque	Mass
	(deg)		(A)	(Ohms)	(mNm)	(mH)	(g·cm <sup>2</sup> )	(mNm)	(g)
17PM-K049U	1.8	UNI-POLAR	1	3.1	200	3.2	37	10.8	200
17PM-K064U	1.8	UNI-POLAR	0.6	8.3	200	8.1	37	10.8	200
17PM-K142U	1.8	UNI-POLAR	1.4	2.3	280	3.2	62	11.8	300
17PM-K149U	1.8	UNI-POLAR	1	4.3	280	6.0	62	11.8	300
17PM-K249U	1.8	UNI-POLAR	0.8	2.7	100	3.0	24	4.3	180
17PM-K264U	1.8	UNI-POLAR	0.6	6.9	100	7.4	24	4.3	180
17PM-K342U	1.8	UNI-POLAR	1.4	2.0	250	2.5	50	11.3	250
17PM-K349U	1.8	UNI-POLAR	1	3.6	250	4.7	50	11.3	250
17PM-K442U	1.8	UNI-POLAR	1.4	2.8	400	3.4	75	16.7	350
17PM-K449U	1.8	UNI-POLAR	1	4.9	400	6.5	75	16.7	350
17PM-K749U	1.8	UNI-POLAR	0.9	2.2	50	0.4	11	2.8	150
17PM-K764U	1.8	UNI-POLAR	0.6	5.6	50	1.0	11	2.8	150
17PM-KA39U	1.8	UNI-POLAR	1.4	2.9	485	4.0	120	21.6	490
17PM-KA46U	1.8	UNI-POLAR	1	5.6	485	8.1	120	21.6	490
17PM-K049B	1.8	BI-POLAR	0.7	6.2	270	12.8	37	10.8	200
17PM-K142B	1.8	BI-POLAR	1	4.6	380	12.9	62	11.8	300
17PM-K249B	1.8	BI-POLAR	0.6	5.4	140	12.0	24	4.3	180
17PM-K342B	1.8	BI-POLAR	0.9	4.0	310	9.9	50	11.3	250
17PM-K442B	1.8	BI-POLAR	0.9	5.6	500	13.6	75	16.7	350
17PM-K749B	1.8	BI-POLAR	0.6	4.4	65	1.6	11	2.8	150
17PM-KA39B	1.8	BI-POLAR	1	5.8	610	15.9	120	21.6	490

# ■ トルク・スピード特性 Torque/Speed Characteristics

Model No: 17PM-K049U,K064U,K049B  
 Driver: Chopper Dual  
 Supply Voltage: 24.0 (Volt)

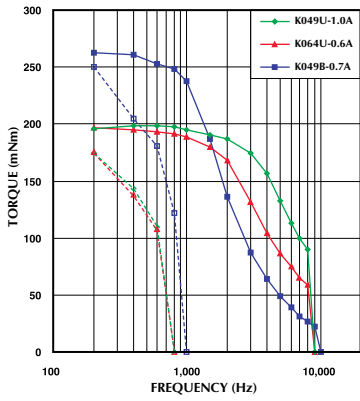

Model No: 17PM-K142U,K149U,K142B  
 Driver: Chopper Dual  
 Supply Voltage: 24.0 (Volt)

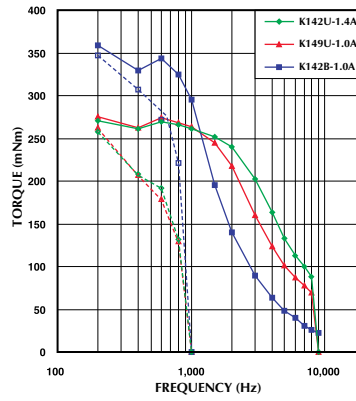

Model No: 17PM-K249U,K264U,K249B  
 Driver: Chopper Dual  
 Supply Voltage: 24.0 (Volt)

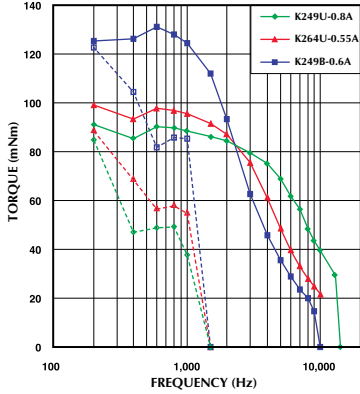

Model No: 17PM-K342U,K349U,K342B  
 Driver: Chopper Dual  
 Supply Voltage: 24.0 (Volt)

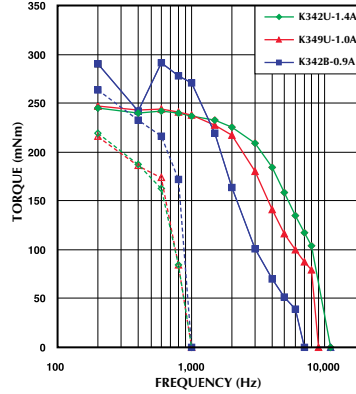

Model No: 17PM-K442U,K449U,K442B  
 Driver: Chopper Dual  
 Supply Voltage: 24.0 (Volt)

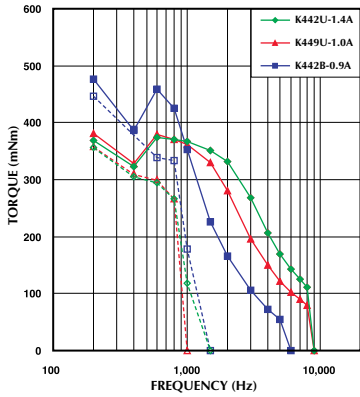

Model No: 17PM-K749U,K764U,K749B  
 Driver: Chopper Dual  
 Supply Voltage: 24.0 (Volt)

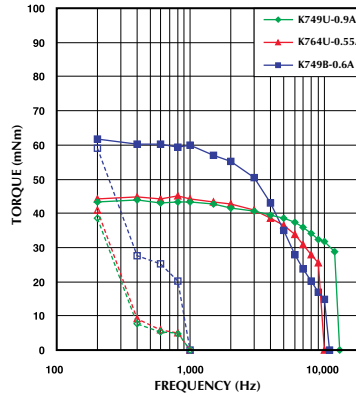

— : PULL OUT  
 - - - : PULL IN

Model No: 17PM-KA39U,KA46U,KA39B  
 Driver: Chopper Dual  
 Supply Voltage: 24.0 (Volt)

