

42 3.75°

17PU-H

3.75°

■ 外観図 Outline

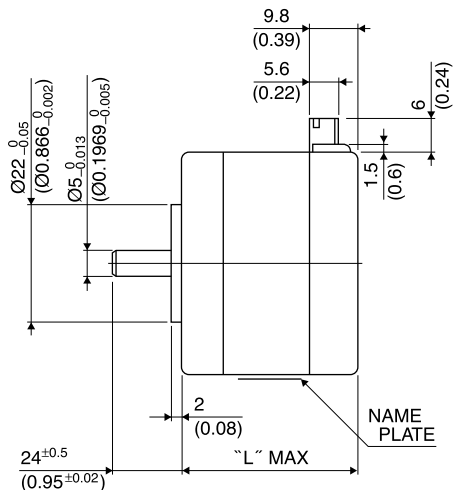
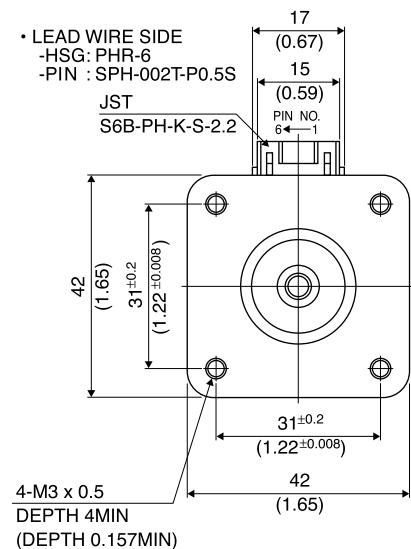

Hybrid

UNIT: $\frac{\text{mm}}{\text{(inch)}}$

結線表 PIN NO. vs. PHASE

相 (PHASE)	A	A COM	\bar{A}	B	B COM	\bar{B}
ピン番号 (PIN NO.)	4	5	6	3	2	1

	"L"
17PU-H7**	26 (1.02)
17PU-H2**	30 (1.18)
17PU-H0**	34 (1.34)
17PU-H3**	38 (1.50)
17PU-H1**	42 (1.65)
17PU-H4**	48 (1.89)

■ 仕様 Specifications

型式	ステップ角	ドライブ方式	定格電流	巻線抵抗	ホールディングトルク	インダクタンス	ロータイナーシャ	デテントトルク	質量
Model	Step Angle	Drive Sequence	Rated Current	Resistance	Holding Torque	Inductance	Rotor Inertia	Detent Torque	Mass
	(deg)		(A)	(Ohms)	(mNm)	(mH)	(g·cm ²)	(mNm)	(g)
17PU-H049U	3.75	UNI-POLAR	1	3.1	105	2.5	37	25.5	200
17PU-H064U	3.75	UNI-POLAR	0.6	8.3	105	6.4	37	25.5	200
17PU-H142U	3.75	UNI-POLAR	1.4	2.3	150	2.2	62	26.5	300
17PU-H149U	3.75	UNI-POLAR	1	4.3	150	4.3	62	26.5	300
17PU-H249U	3.75	UNI-POLAR	0.8	2.7	50	2.1	24	8.2	180
17PU-H264U	3.75	UNI-POLAR	0.6	6.9	50	5.3	24	8.2	180
17PU-H342U	3.75	UNI-POLAR	1.4	2.0	140	1.7	50	29.4	250
17PU-H349U	3.75	UNI-POLAR	1	3.6	140	3.3	50	29.4	250
17PU-H442U	3.75	UNI-POLAR	1.4	2.8	190	2.5	75	44.1	350
17PU-H449U	3.75	UNI-POLAR	1	4.9	190	5.0	75	44.1	350
17PU-H749U	3.75	UNI-POLAR	0.9	2.2	23	1.4	11	2.4	150
17PU-H764U	3.75	UNI-POLAR	0.6	5.6	23	3.3	11	2.4	150
17PU-H049B	3.75	BI-POLAR	0.7	6.2	145	10.1	37	25.5	200
17PU-H142B	3.75	BI-POLAR	1	4.6	200	9.0	62	26.5	300
17PU-H249B	3.75	BI-POLAR	0.6	5.4	73	8.5	24	8.2	180
17PU-H342B	3.75	BI-POLAR	0.9	4.0	170	6.9	50	29.4	250
17PU-H442B	3.75	BI-POLAR	0.9	5.6	250	10.0	75	44.1	350
17PU-H749B	3.75	BI-POLAR	0.6	4.4	32	5.4	11	2.4	150

■ トルク・スピード特性 Torque/Speed Characteristics

Model No: 17PU-H049U,H064U,H049B
 Driver: Chopper Dual
 Supply Voltage: 24.0 (Volt)

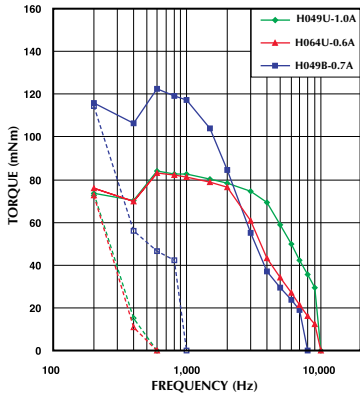

Model No: 17PU-H142U,H149U,H142B
 Driver: Chopper Dual
 Supply Voltage: 24.0 (Volt)

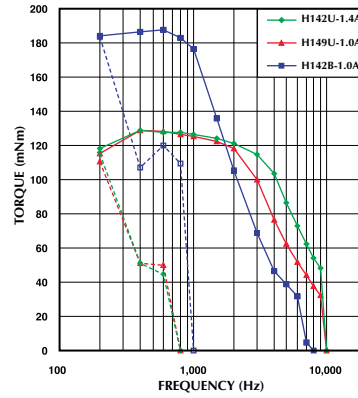

Model No: 17PU-H249U,H264U,H249B
 Driver: Chopper Dual
 Supply Voltage: 24.0 (Volt)

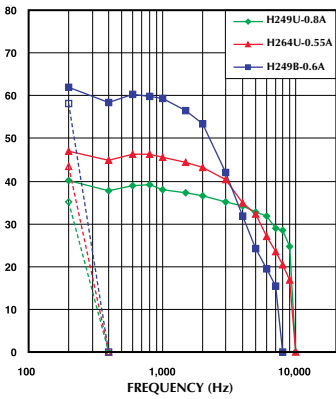

Model No: 17PU-H342U,H349U,H342B
 Driver: Chopper Dual
 Supply Voltage: 24.0 (Volt)

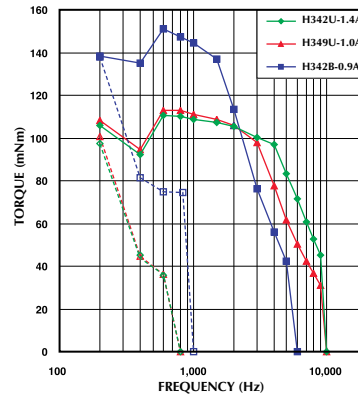

Model No: 17PU-H442U,H449U,H442B
 Driver: Chopper Dual
 Supply Voltage: 24.0 (Volt)

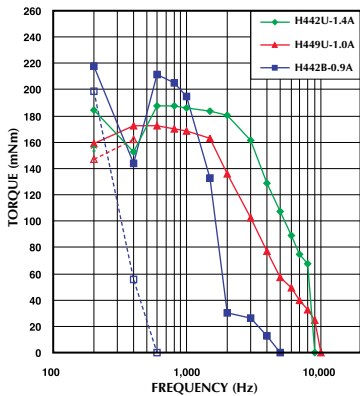

Model No: 17PU-H749U,H764U,H749B
 Driver: Chopper Dual
 Supply Voltage: 24.0 (Volt)

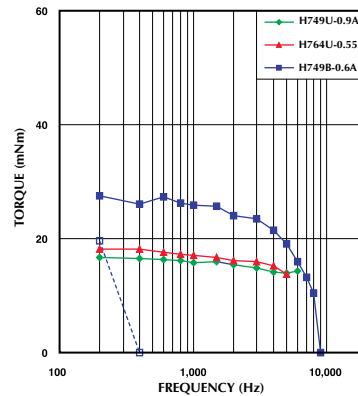

— : PULL OUT
 - - - : PULL IN