

MDN1X

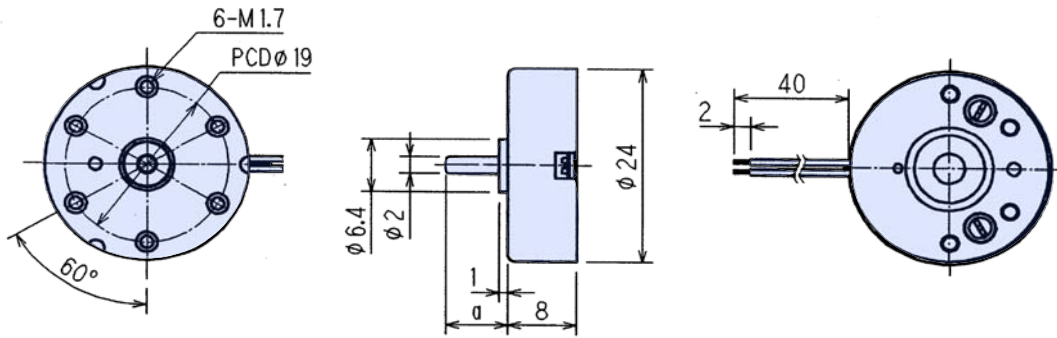

Weight: 11.8 g

Outline UNIT:mm



Specifications

Model	Operating Voltage (V)	Rated Voltage (V)	No Load Speed (min ⁻¹)	No Load Current (mA)	Rated Load		Rated Load Speed (min ⁻¹)	Rated Load Current (mA)	Starting Torque		Starting Current (mA)	Shaft Length (mm)
					(gf·cm)	(mN·m)			(gf·cm)	(mN·m)		
MDN1XL3PSBS	0.5 to 4.5	2.0	3500	23	3.0	0.294	2438	84	9.9	1.0	223	a=6

Characteristics

