

# 1A LDO with soft-start Monolithic IC MM3529 Series

## Outline

This IC is a 1A LDO with soft-start.

The soft-start can reduce a rush current by the Cs capacitor on start-up.

Package is SOT89-5A which can be the high radiation of heat on small space.

## Features

1. Maximum input voltage	6V
2. Output current	1A
3. No load input current	50μA typ.
4. Input current (OFF)	1μA max.
5. Output voltage range	1.2~5.0V
6. Output voltage accuracy	±1% or ±15mV
7. Dropout voltage	0.7V max. (Io=1A, Vo=3V)
8. Line regulation	±0.2%/V max.
9. Load regulation	130mV max.(Io=1~1000mA)
10. Ripple rejection	70dB typ. (f=1kHz)
11. Thermal shutdown	Built-in
12. Output Capacitor	1μF

## Package

SOT89-5A  
SSON-6A

## Applications

1. TV
2. BD recorder/player
3. Printer
4. Game

**Model Name**

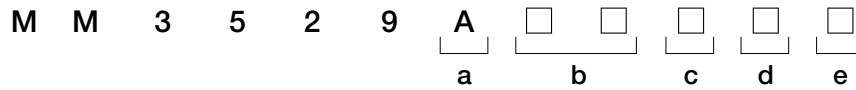

a		b	
Function Type		Voltage Output RANK	
A	CE=H-Active, with Discharge Function	12	The combination of each regulator output voltage is specified by design serial numbers. It is assigned in order from 12. Output voltage can be set in the range.
		2	
		50	

c		d	
Package		Packing Specifications	
P	SOT89-5A	R	R HOUSING (SOT89-5A, SSON-6A)
R	SSON-6A	L	L HOUSING
		F	F HOUSING
		B	B HOUSING

e	
E	EMBOSS TAPE

• Any products mentioned in this catalog are subject to any modification in their appearance and others for improvements without prior notification.  
 • The details listed here are not a guarantee of the individual products at the time of ordering. When using the products, you will be asked to check their specifications.

**Block Diagram**

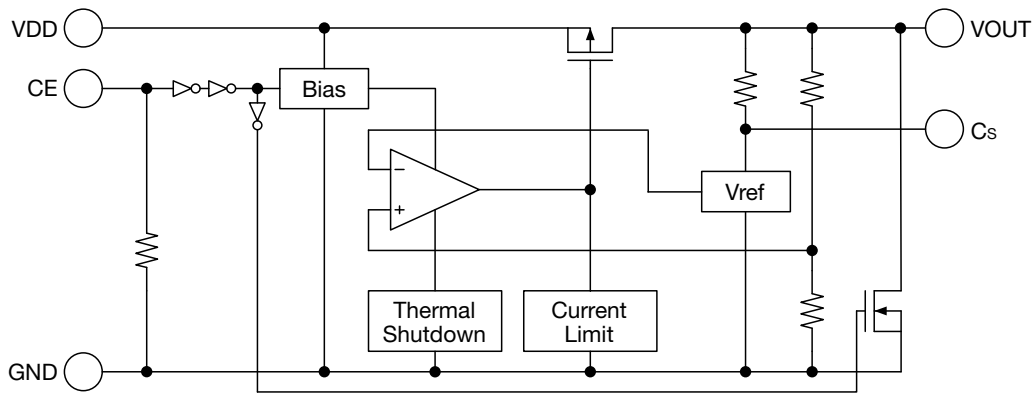

**Pin Assignment**

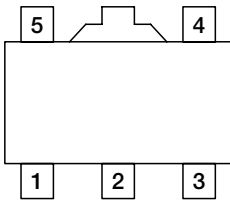

SOT89-5A  
(TOP VIEW)

1	Cs
2	GND
3	CE
4	VDD
5	VOUT

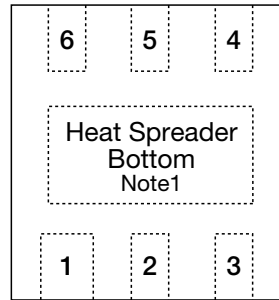

SSON-6A  
(TOP VIEW)

1	VOUT
2	Cs
3	GND
4	CE
5	NC
6	VDD

• Any products mentioned in this catalog are subject to any modification in their appearance and others for improvements without prior notification.  
 • The details listed here are not a guarantee of the individual products at the time of ordering. When using the products, you will be asked to check their specifications.

## Pin Description

### SOT89-5A

Pin No.	Pin name	Functions						
1	Cs	Soft-start pin (Note2)						
2	GND	GND pin						
3	CE	ON/OFF-Control pin (with CE pull-down resistor) <table border="1" style="margin: 10px 0;"> <thead> <tr> <th>CE</th> <th>Output</th> </tr> </thead> <tbody> <tr> <td>H</td> <td>ON</td> </tr> <tr> <td>L</td> <td>OFF</td> </tr> </tbody> </table> Connect CE pin with VDD pin, when it is not used.	CE	Output	H	ON	L	OFF
CE	Output							
H	ON							
L	OFF							
4	VDD	Voltage-supply pin						
5	V <sub>OUT</sub>	Output pin						

### SSON-6A

Pin No.	Pin name	Functions						
1	V <sub>OUT</sub>	Output pin						
2	Cs	Soft-start pin (Note2)						
3	GND	GND pin						
4	CE	ON/OFF-Control pin (with CE pull-down resistor) <table border="1" style="margin: 10px 0;"> <thead> <tr> <th>CE</th> <th>Output</th> </tr> </thead> <tbody> <tr> <td>H</td> <td>ON</td> </tr> <tr> <td>L</td> <td>OFF</td> </tr> </tbody> </table> Connect CE pin with VDD pin, when it is not used.	CE	Output	H	ON	L	OFF
CE	Output							
H	ON							
L	OFF							
5	NC	No connection						
6	VDD	Voltage-supply pin						

Note2 : Must be connect capacitor to Soft-Start pin.  
 Refer to 9 and 19 for details.

**Absolute Maximum Ratings** (Except where noted otherwise Ta=25°C)

Item	Symbol	Ratings		Units
Storage Temperature	T <sub>stg</sub>	-55~+150		°C
Junction Temperature	T <sub>JMAX</sub>	150		°C
Supply Voltage	V <sub>DD</sub>	-0.3~+6.5		V
CE input Voltage	V <sub>CE</sub>	-0.3~+6.5		V
Output Voltage	V <sub>OUT</sub>	-0.3~V <sub>DD</sub> +0.3		V
Cs Voltage	V <sub>CS</sub>	-0.3~V <sub>DD</sub> +0.3		V
Output Current	I <sub>OMAX</sub>	1.2		A
Power Dissipation (Note3)	Pd	1780	SOT89-5A	mW
		1250	SSON-6A	

Note3 : JEDEC51-7 standard 114.3mm × 76.2mm t=1.6mm

**Recommended Operating Conditions** (Except where noted otherwise Ta=25°C)

Item	Symbol	Ratings	Units
Operating Ambient Temperature	T <sub>opr</sub>	-40~+85	°C
Operating Voltage	V <sub>op</sub>	1.6~6.0	V
Output Current	I <sub>OUT</sub>	0~1	A

**Electrical Characteristics 1** (Except where noted otherwise  $V_{DD}=V_{OUT}(TYP.)+1V$ ,  $V_{CE}=V_{DD}$ ,  $T_a=25^{\circ}C$ )

Item	Symbol	Measurement conditions	Min.	Typ.	Max.	Units
Input Current (OFF)	$I_{DDOFF}$	$V_{CE}=0V$		0.1	1.0	$\mu A$
No-Load Input Current	$I_{DD}$	$I_{OUT}=0mA$		50	80	$\mu A$
Output Voltage	$V_{OUT}$	$I_{OUT}=10mA, 1.5 \leq V_{OUT}$	$\times 0.99$		$\times 1.01$	V
		$I_{OUT}=10mA, V_{OUT} < 1.5V$	-0.015		+0.015	
Line Regulation	$V_{LINE}$	$V_{OUT}(typ.)+0.5V \leq V_{DD} \leq 6.0V$ $I_{OUT}=100mA, 2.0V \leq V_{OUT}$		0.05	0.2	% / V
		$2.5V \leq V_{DD} \leq 6.0V$ $I_{OUT}=100mA, V_{OUT} < 2.0V$				
Load Regulation	$V_{LOAD}$	$1mA \leq I_{OUT} \leq 1000mA$		75	130	mV
Dropout Voltage	$V_{IO}$	Please refer to another page				V
Ripple Rejection	RR	$f=1kHz, V_{ripple}=0.5V, I_{OUT}=10mA$ $1.5 \leq V_{OUT}$		70		dB
		$f=1kHz, V_{ripple}=0.5V, I_{OUT}=10mA$ $V_{DD}=2.5V, V_{OUT} < 1.5V$				
$V_{OUT}$ Temperature Coefficient (Note4)	$\Delta V_{OUT} / \Delta T$	$I_{OUT}=100mA,$ $-40 \leq T_{op} \leq +85^{\circ}C$		100		ppm / $^{\circ}C$
Output Current	$I_{OUT}$		1			A
Output Short-Circuit Current (Note4)	$I_{short}$	$V_{OUT}=0V$		30		mA
Thermal ShutDown Detect Temperature (Note4)	$T_{SD}$			150		$^{\circ}C$
Thermal ShutDown Release Temperature (Note4)	$T_{SR}$			125		$^{\circ}C$
Output Rise Time (Note4)	$t_r$	$C_S=0.1\mu F$		1.5		ms
CE High Threshold Voltage	$V_{CEH}$		1.2		6.0	V
CE Low Threshold Voltage	$V_{CEL}$				0.3	V
CE Pin Current	$I_{CE}$	$V_{CE}=2.0V$		0.3		$\mu A$
Output NMOS ON Resistance (Note4)	$R_{DON}$	$V_{CE}=0V, V_{DD}=4V$		30		$\Omega$

Note4 : The parameter is guaranteed by design.

**Electrical Characteristics 2** (Except where noted otherwise  $V_{DD}=V_{OUT}(TYP.)+1V$ ,  $V_{CE}=V_{DD}$ ,  $T_a=25^{\circ}C$ )

Model No.	Item							
	Output Voltage				Dropout Voltage			
	$V_{OUT}$ (V)				$V_{io}$ (V)			
	Measurement Conditions	Min.	Typ.	Max.	Measurement Conditions	Min.	Typ.	Max.
MM3529A12	$I_{OUT}=10mA$	1.185	1.200	1.215	$I_{OUT}=300mA$ , $V_{OUT}<2.0V$ (Note5)		0.30	0.40
MM3529A13		1.285	1.300	1.315				
MM3529A14		1.385	1.400	1.415				
MM3529A15		1.485	1.500	1.515				
MM3529A16		1.584	1.600	1.616				
MM3529A17		1.683	1.700	1.717				
MM3529A18		1.782	1.800	1.818				
MM3529A19		1.881	1.900	1.919				
MM3529A20		1.980	2.000	2.020				
MM3529A21		2.079	2.100	2.121				
MM3529A22		2.178	2.200	2.222	$I_{OUT}=300mA$ , $2.0V \leq V_{OUT}$ , $V_{DD}=V_{OUT}(TYP.)-0.2V$		0.21	0.27
MM3529A23		2.277	2.300	2.323				
MM3529A24		2.376	2.400	2.424				
MM3529A25		2.475	2.500	2.525				
MM3529A26		2.574	2.600	2.626				
MM3529A27		2.673	2.700	2.727				
MM3529A28		2.772	2.800	2.828				
MM3529A29		2.871	2.900	2.929				
MM3529A30		2.970	3.000	3.030				
MM3529A31		3.069	3.100	3.131				
MM3529A32		3.168	3.200	3.232				
MM3529A33		3.267	3.300	3.333				
MM3529A34		3.366	3.400	3.434				
MM3529A35		3.465	3.500	3.535				
MM3529A36		3.564	3.600	3.636				
MM3529A37		3.663	3.700	3.737				
MM3529A38		3.762	3.800	3.838				
MM3529A39		3.861	3.900	3.939				
MM3529A40		3.960	4.000	4.040				
MM3529A41		4.059	4.100	4.141				
MM3529A42	4.158	4.200	4.242					
MM3529A43	4.257	4.300	4.343					
MM3529A44	4.356	4.400	4.444					
MM3529A45	4.455	4.500	4.545					
MM3529A46	4.554	4.600	4.646					
MM3529A47	4.653	4.700	4.747					
MM3529A48	4.752	4.800	4.848					
MM3529A49	4.851	4.900	4.949					
MM3529A50	4.950	5.000	5.050					

Note5 : Dropout voltage maximum value in the input and it is confirmed that there is no output abnormal voltage impression the 300mA in the model less than  $V_{OUT}<2.0V$ .

• Any products mentioned in this catalog are subject to any modification in their appearance and others for improvements without prior notification.  
 • The details listed here are not a guarantee of the individual products at the time of ordering. When using the products, you will be asked to check their specifications.

Model No.	Item							
	Output Voltage				Dropout Voltage			
	V <sub>OUT</sub> (V)				V <sub>IO</sub> (V)			
	Measurement Conditions	Min.	Typ.	Max.	Measurement Conditions	Min.	Typ.	Max.
MM3529A12	I <sub>OUT</sub> =10mA	1.185	1.200	1.215	I <sub>OUT</sub> =1A, V <sub>OUT</sub> <2.0V (Note6)		1.00	1.30
MM3529A13		1.285	1.300	1.315				
MM3529A14		1.385	1.400	1.415				
MM3529A15		1.485	1.500	1.515				
MM3529A16		1.584	1.600	1.616				
MM3529A17		1.683	1.700	1.717				
MM3529A18		1.782	1.800	1.818				
MM3529A19		1.881	1.900	1.919				
MM3529A20		1.980	2.000	2.020				
MM3529A21		2.079	2.100	2.121				
MM3529A22		2.178	2.200	2.222	I <sub>OUT</sub> =1A, 2.0V ≤ V <sub>OUT</sub> , V <sub>DD</sub> =V <sub>OUT</sub> (TYP.) -0.2V		0.70	0.90
MM3529A23		2.277	2.300	2.323				
MM3529A24		2.376	2.400	2.424				
MM3529A25		2.475	2.500	2.525				
MM3529A26		2.574	2.600	2.626				
MM3529A27		2.673	2.700	2.727				
MM3529A28		2.772	2.800	2.828				
MM3529A29		2.871	2.900	2.929				
MM3529A30		2.970	3.000	3.030				
MM3529A31		3.069	3.100	3.131				
MM3529A32		3.168	3.200	3.232				
MM3529A33		3.267	3.300	3.333				
MM3529A34		3.366	3.400	3.434				
MM3529A35		3.465	3.500	3.535				
MM3529A36		3.564	3.600	3.636				
MM3529A37		3.663	3.700	3.737				
MM3529A38		3.762	3.800	3.838				
MM3529A39		3.861	3.900	3.939				
MM3529A40		3.960	4.000	4.040				
MM3529A41		4.059	4.100	4.141				
MM3529A42	4.158	4.200	4.242					
MM3529A43	4.257	4.300	4.343					
MM3529A44	4.356	4.400	4.444					
MM3529A45	4.455	4.500	4.545					
MM3529A46	4.554	4.600	4.646					
MM3529A47	4.653	4.700	4.747					
MM3529A48	4.752	4.800	4.848					
MM3529A49	4.851	4.900	4.949					
MM3529A50	4.950	5.000	5.050					

Note6 : Dropout voltage maximum value in the input and it is confirmed that there is no output abnormal voltage impression the 1A in the model less than V<sub>OUT</sub><2.0V.



## Measuring Circuit

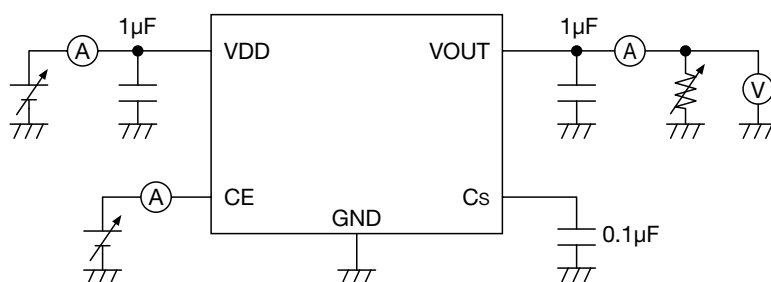

## Application Circuit

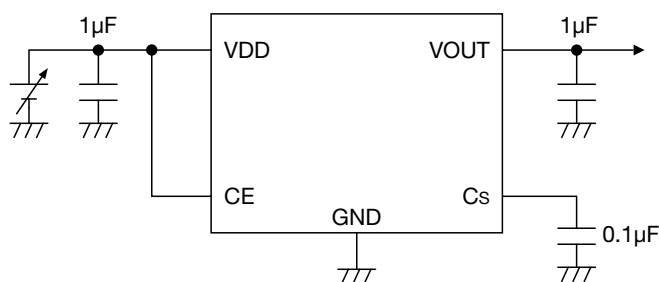

\* Temperature Characteristics : B

(Reference example of external parts)

- Output capacitor                      Ceramic capacitor 1.0µF
- Input capacitor                        Ceramic capacitor 1.0µF
- Softstart Capacitor                  Ceramic capacitor 0.1µF

· In the event a problem which may affect industrial property or any other rights of us or a third party is encountered during the use of information described in these circuit, we shall not be liable for any such problem, nor grant a license therefore.

· Note

1. There is a possibility with deterioration and destruction of IC when using it exceeding the absolute maximum rating.  
The absolute maximum rating , Never exceed it.  
The functional operation is not assured.
2. There is a possibility that it becomes impossible to maintain this performance and reliability IC original when using it exceeding recommended operation voltage.  
Please use it in recommended operation voltage.
3. Due to restrictions on the package power dissipation, the output current value may not be satisfied.  
Attention should be paid to the power dissipation of the package when the output current is large or the voltage between Input and Output is high.
4. The output capacitor is required between output and GND to prevent oscillation.
5. The ESR of capacitor must be defined in ESR stability area.  
It is possible to use a ceramic capacitor without ESR resistance for output.  
The ceramic capacitor must be used more than 1.0 $\mu$ F and B temperature characteristics.
6. The wire of VDD and GND is required to print full ground plane for noise and stability.
7. The input capacitor must be connected a distance of less than 1cm from input pin.
8. In case the output voltage is above the input voltage, the overcurrent flow by internal parasitic diode from output to input. In such application, the external bypass diode must be connected between output and input pin.

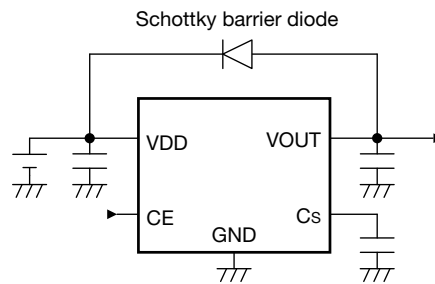

9. Please connect the soft-start capacitor(Cs) more than 0.01 $\mu$ F with the terminal Cs.
10. The output capacitor and the softstart capacitor must be connected it within the limits a rush current peak level 1A showed in the typical performance characteristics.
11. When rush current exceeds current limit characteristics, it is restricted with the current limit set up with the chip, an output rise time is uncontrollable by soft-start capacitor.
12. When use connecting VDD and CE, in the case of starting VDD in input rise time longer then the set-up soft-start time, an output rise time is decide by a VDD input rise time.
13. Please do not give the voltage to the terminal Cs.
14. When the voltage of the soft-start pin is higher than the voltage of VDD, it becomes test mode.  
In that case, there is a possibility that the output voltage becomes unstable.
15. It is able to an unstable operation when you use the capacitor with intense capacitance change  
The capacitor has the dependency at the power-supply voltage and the temperature.  
The capacity value changes by the environment used. Please evaluate IC in the set.
16. The overcurrent protection circuit of the vertical type is built into this IC.
17. There is a possibility that IC generates heat when the output terminal is short-circuited.  
However, the thermal shutdown circuit operates, and it will do operation that protects IC.  
The thermal shutdown circuit is designed only to shut the IC off to prevent thermal runaway.  
Do not continue to use the IC in an environment where the operation of this circuit is assumed.  
The characteristic changes depending on the substrate condition.  
Please evaluate IC in the set.
18. It returns automatically in temperature returned after it shuts down by self-generation of heat.  
After it returns, it shuts down again by self-generation of heat. It is necessary to change the environment used (IC consumption, temperature) if it operates in upper cycle.

19. When VDD rise time is longer than Vout rise time, Vout rise time is decided by VDD rise time. At this time, Vout is may rose more than typical voltage.

Please set to soft-start capacitor for the VDD rise time in the slash area shown in Fig. 1.

Fig. 1 is common for all the voltage ranks, because soft start time is decided by soft start capacitor and reference voltage.

Please choose to a capacitor in consideration of the dispersion .

Refer to Fig. 2 for a measurement circuit.

Condition : VDD=Vout (typ.) +1V, CE=VDD, Ta=-40°C~+85°C

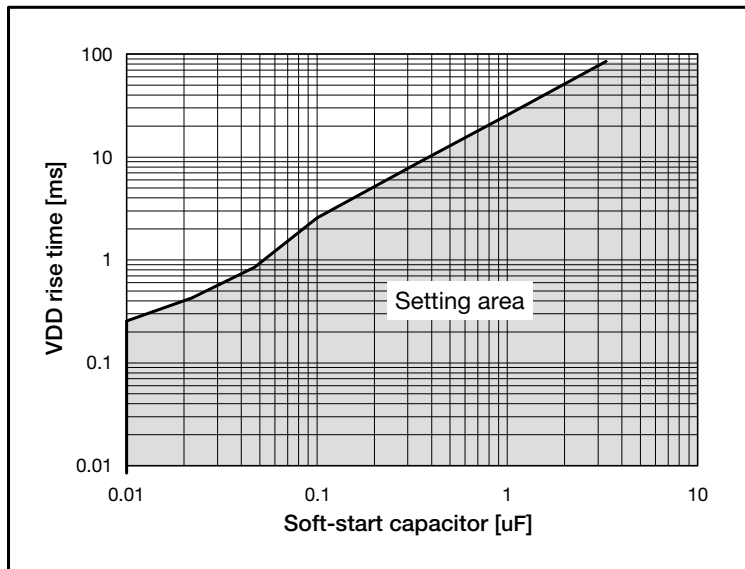
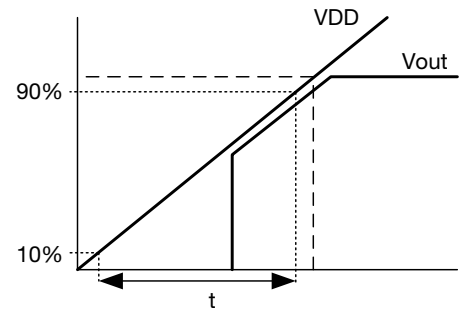

Fig. 1 Soft-start capacitor vs VDD rise time



\* VDD rise time (t) of VDD is judged in time (10%-90%) until VDD reaches Vout setting voltage.

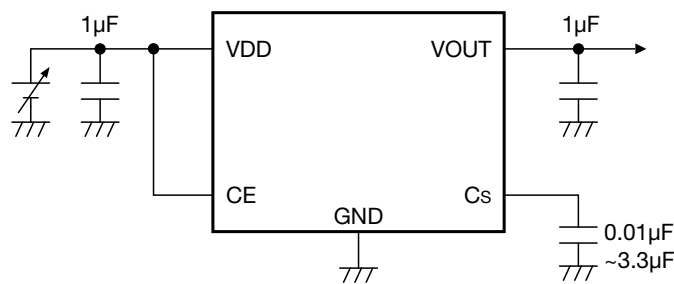

Fig. 2 Test Circuit

## About Power Dissipation

The Power dissipation change if board to mount IC change because radiative heat fix at board. It is reference data below, Evaluate IC in the set.

### SOT89-5A

1. PC Board of glass epoxy

Board size 114.3mm×76.2mm t=1.6mm Copper foil area 80%

Power dissipation 1000mW Ta=25°C

2. JEDEC51-7 standard

Board size 114.3mm×76.2mm t=1.6mm Copper foil area 80%

Power dissipation 1780mW Ta=25°C (It is reference value measured by JEDEC51-7 standard.)

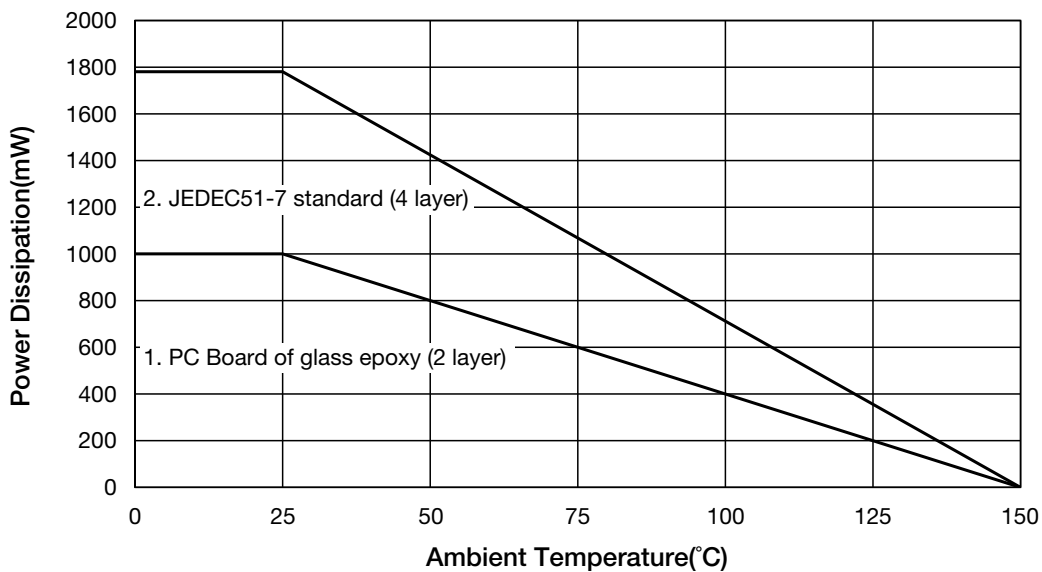

### SSON-6A

1. JEDEC51-7 standard

Board size 114.3mm×76.2mm t=1.6mm Copper foil area 80%

Power dissipation 1250mW Ta=25°C (It is reference value measured by JEDEC51-7 standard.)

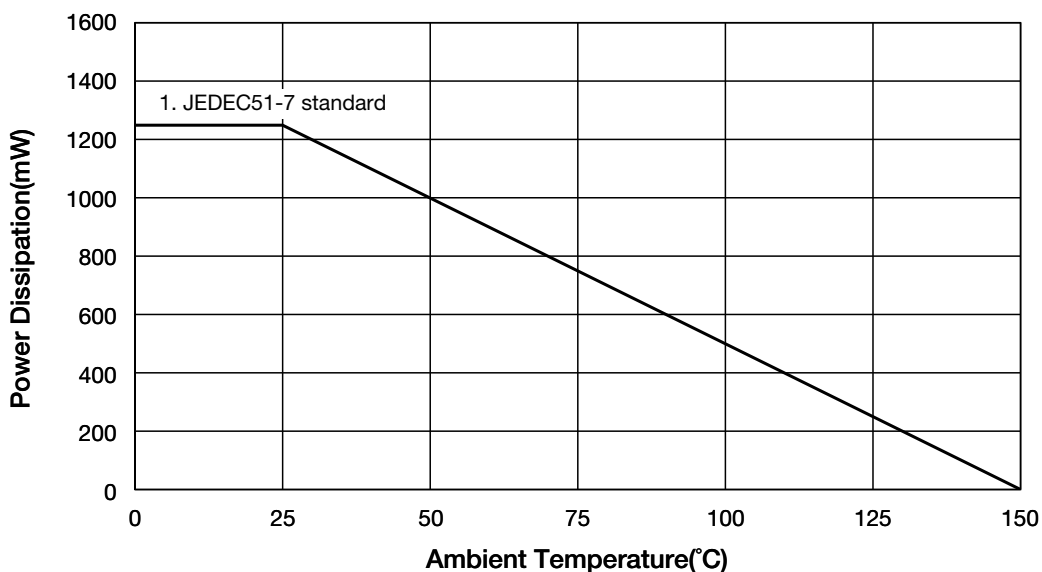

It is recommended to layout the VIA for heat radiation in the GND pattern of reverse (of IC) when there is the GND pattern in the inner layer (in using multi-layer substrate).

By increasing these copper foil pattern area of PCB, Power dissipation improves.

• Any products mentioned in this catalog are subject to any modification in their appearance and others for improvements without prior notification.  
 • The details listed here are not a guarantee of the individual products at the time of ordering. When using the products, you will be asked to check their specifications.

**Characteristics (V<sub>OUT</sub>=1.2V)** (Except where noted otherwise V<sub>DD</sub>=V<sub>OUT</sub>(TYP.)+1V, V<sub>CE</sub>=V<sub>DD</sub>, Ta=25°C)

**Input Voltage - Output Voltage**

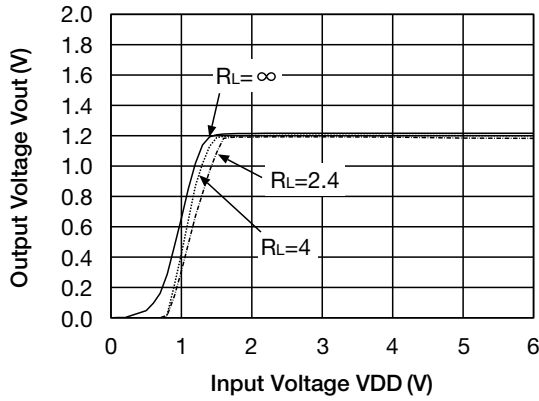

**Input Voltage - Input Current**

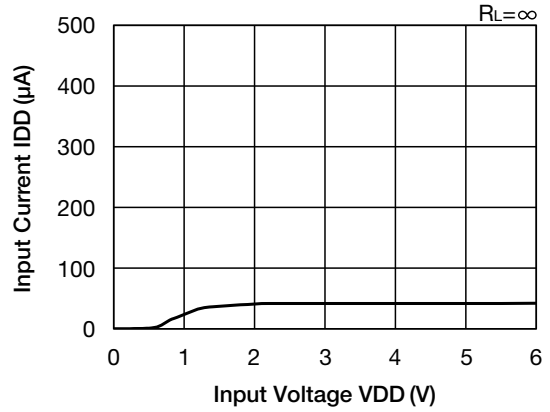

**Load Regulation**

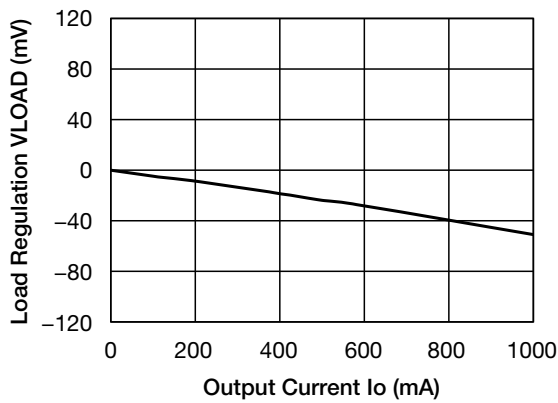

**Line Regulation**

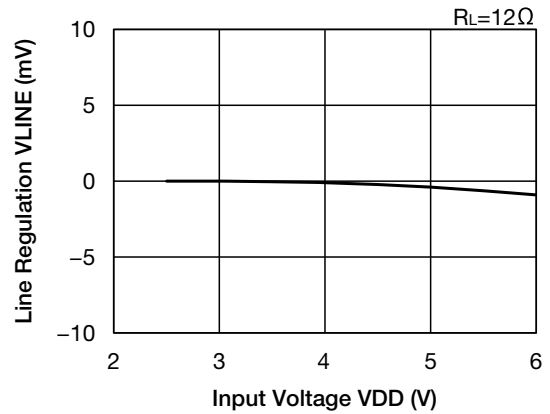

**Ripple Rejection**

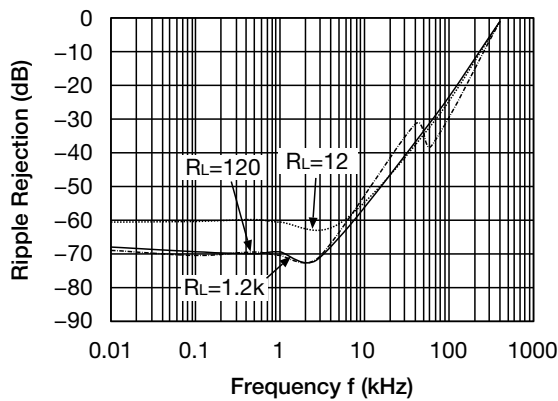

• Any products mentioned in this catalog are subject to any modification in their appearance and others for improvements without prior notification.  
 • The details listed here are not a guarantee of the individual products at the time of ordering. When using the products, you will be asked to check their specifications.

■ Output Current - Output Voltage

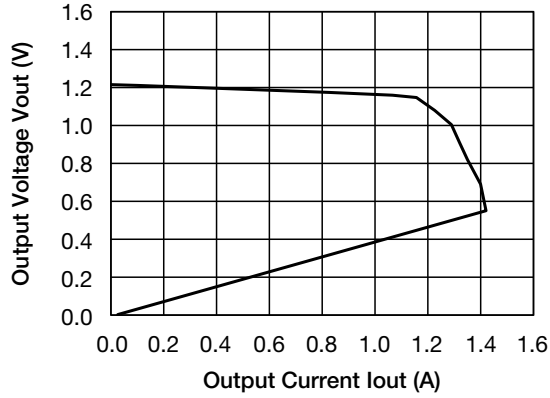

■ ESR stable area

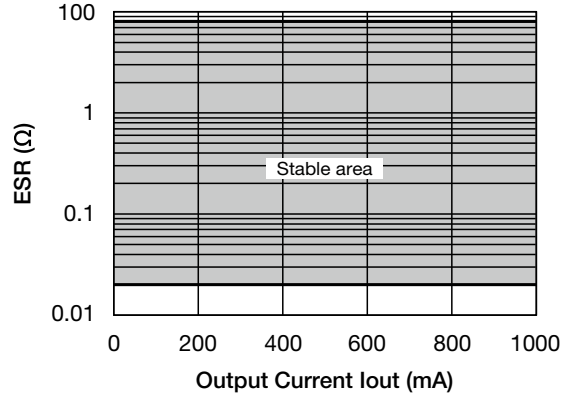

■ Output Voltage Temperature Coefficient

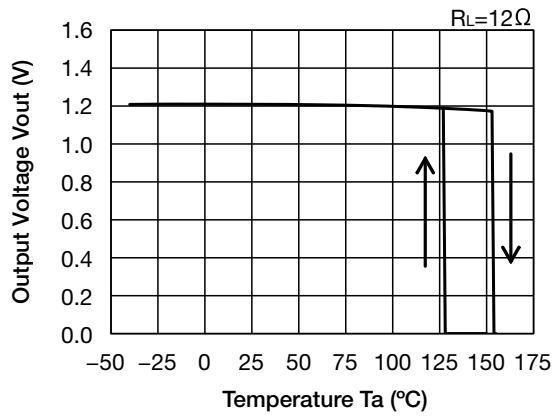

■ Load Transient response (Cin=Co=1μF)

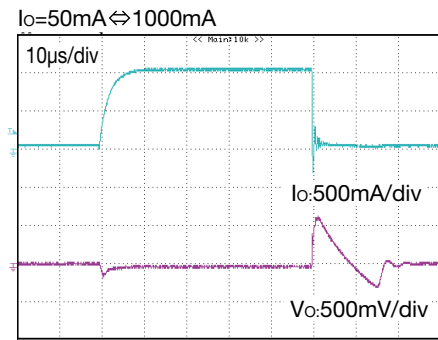
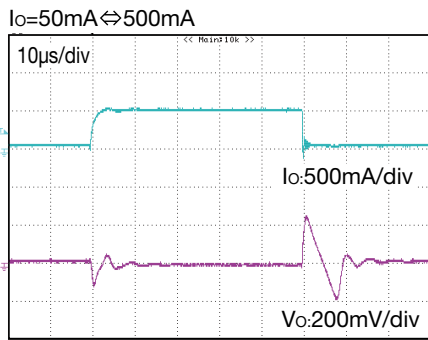

**Input rise characteristics**  
(VDD=0V⇔2.2V, VCE=VDD)

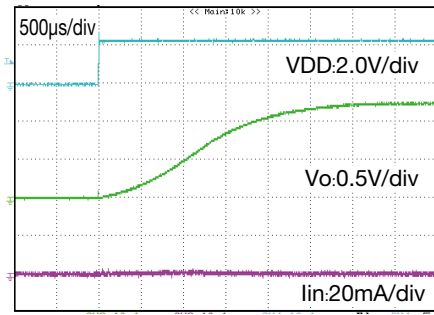

**CE rise characteristics**  
(VDD=2.2V, CE=0V⇔VDD)

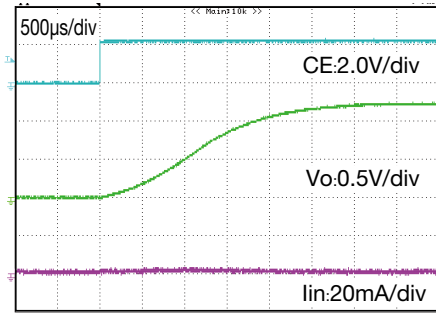

**Vout discharge characteristics**  
(VDD=2.2V, CE=VDD⇔0V)

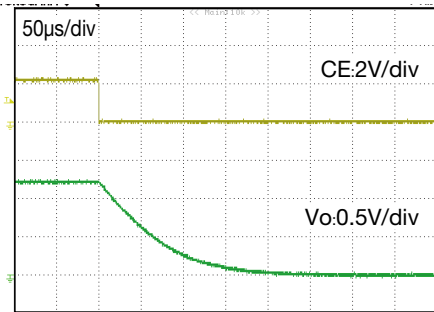

**Cs discharge characteristics**  
(VDD=2.2V, CE=VDD⇔0V)

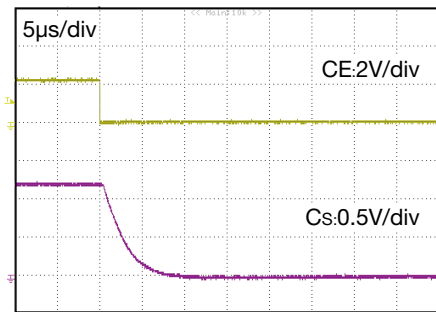

**Rush Current Peak Level**  
Co: Aluminum electrolytic capacitor

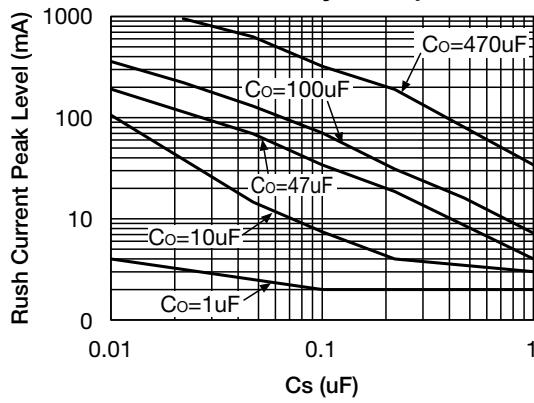

**Output rise time**

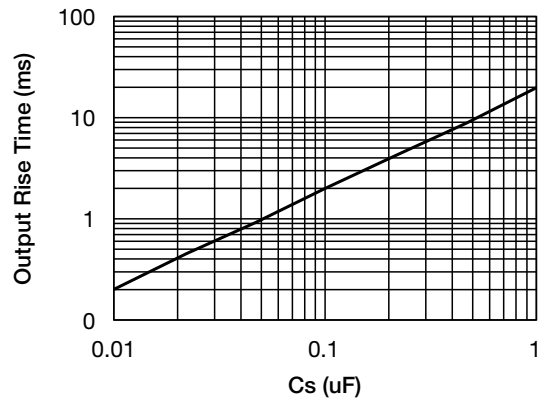

**Characteristics (V<sub>OUT</sub>=3.0V)** (Except where noted otherwise V<sub>DD</sub>=V<sub>OUT</sub>(TYP.)+1V, V<sub>CE</sub>=V<sub>DD</sub>, Ta=25°C)

**Input Voltage - Output Voltage**

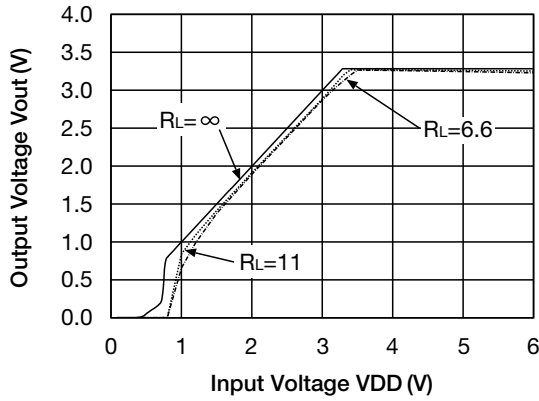

**Input Voltage - Input Current**

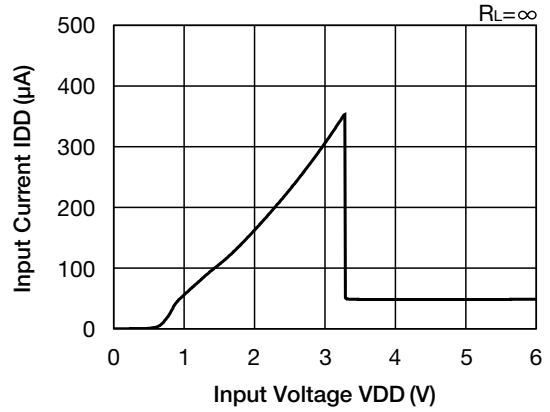

**Load Regulation**

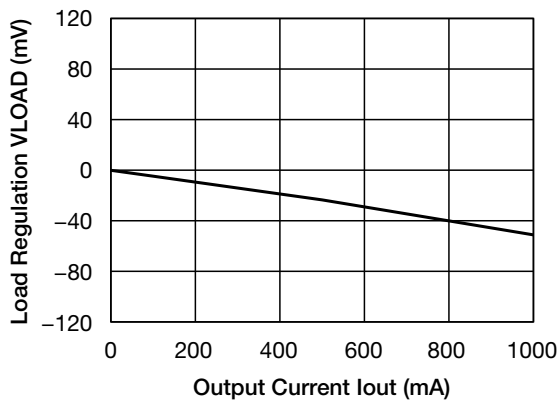

**Line Regulation**

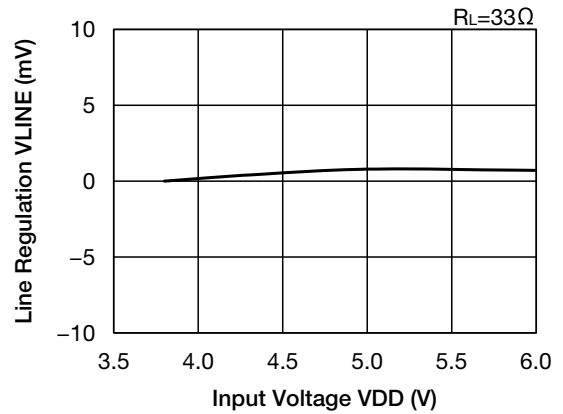

**Dropout Voltage**

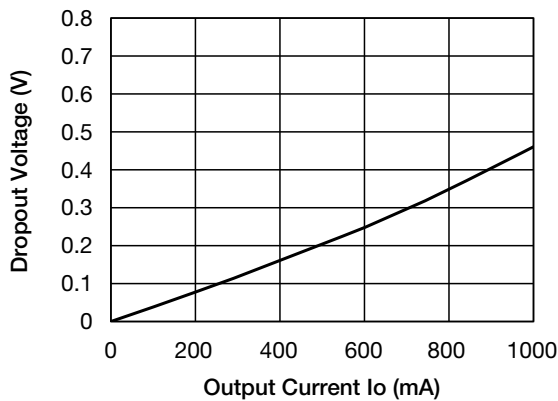

**Ripple Rejection**

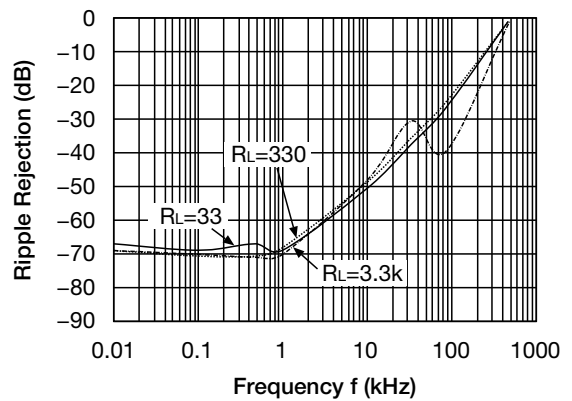

• Any products mentioned in this catalog are subject to any modification in their appearance and others for improvements without prior notification.  
 • The details listed here are not a guarantee of the individual products at the time of ordering. When using the products, you will be asked to check their specifications.



■ Output Current - Output Voltage

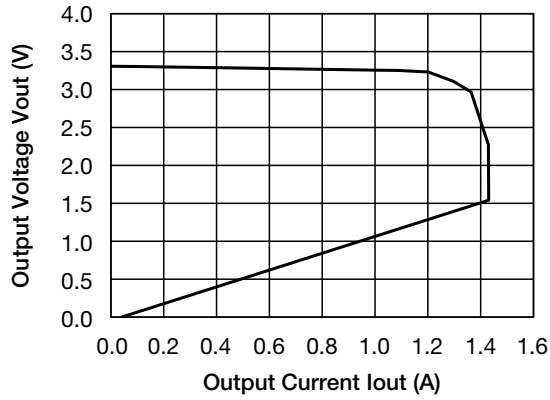

■ ESR stable area

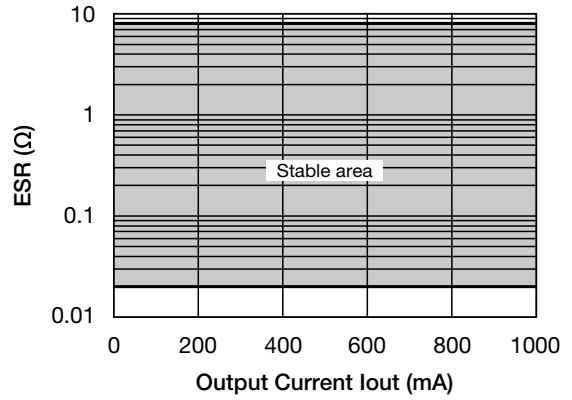

■ Output Voltage Temperature Coefficient

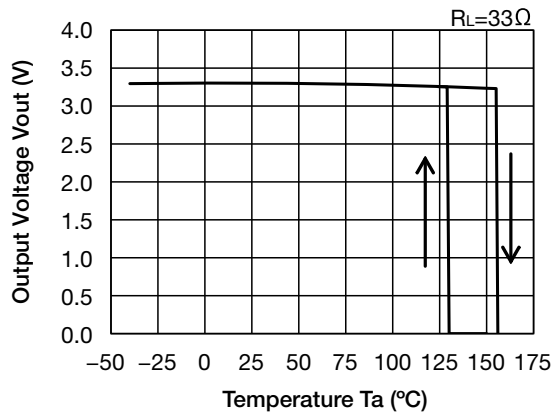

■ Load Transient response (Cin=Co=1μF)

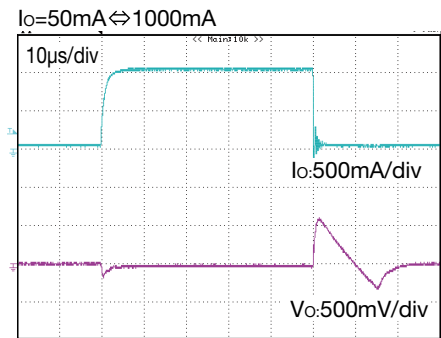
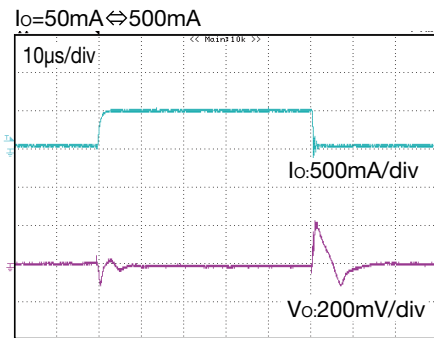

**Input rise characteristics**  
(VDD=0V↔4.3V, VCE=VDD)

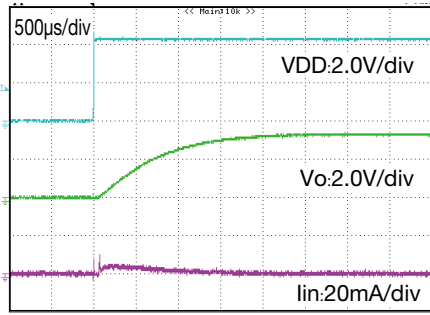

**CE rise characteristics**  
(VDD=4.3V, CE=0V↔VDD)

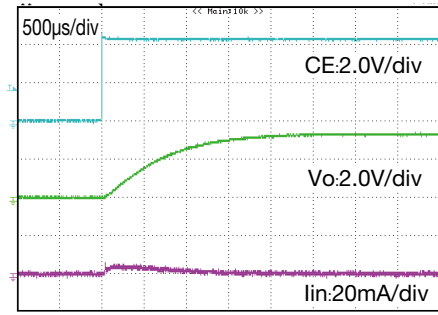

**Vout discharge characteristics**  
(VDD=4.3V, CE=VDD↔0V)

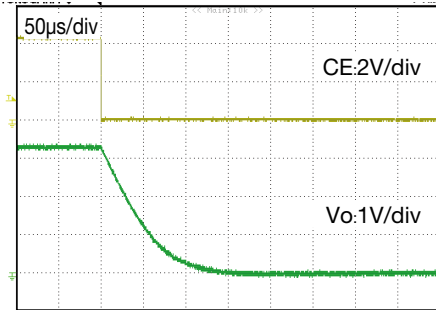

**Cs discharge characteristics**  
(VDD=4.3V, CE=VDD↔0V)

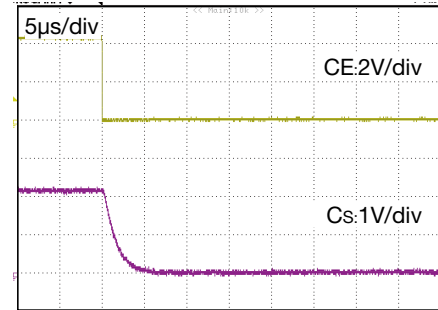

**Rush Current Peak Level**  
Co: Aluminum electrolytic capacitor

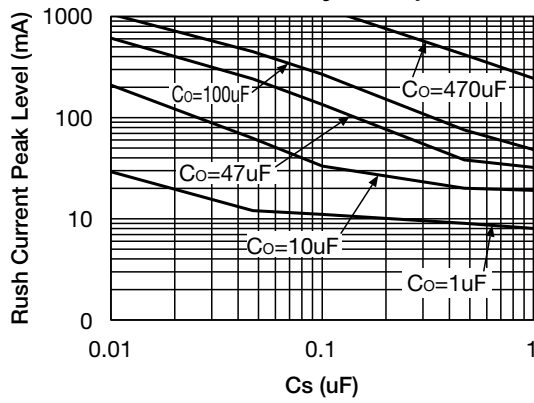

**Output rise time**

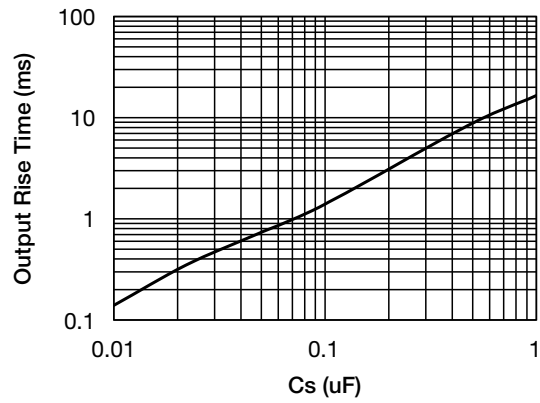

**Characteristics (V<sub>OUT</sub>=5.0V)** (Except where noted otherwise V<sub>DD</sub>=V<sub>OUT</sub>(TYP.)+1V, V<sub>CE</sub>=V<sub>DD</sub>, Ta=25°C)

**Input Voltage - Output Voltage**

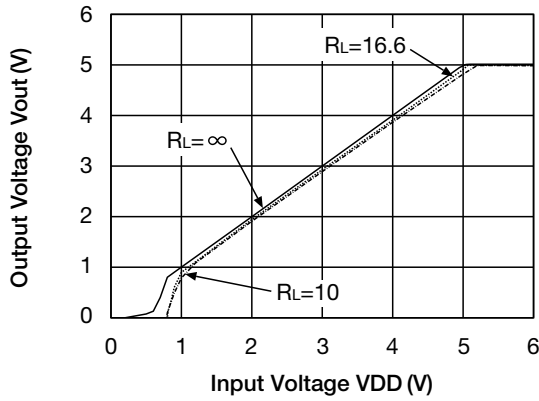

**Input Voltage - Input Current**

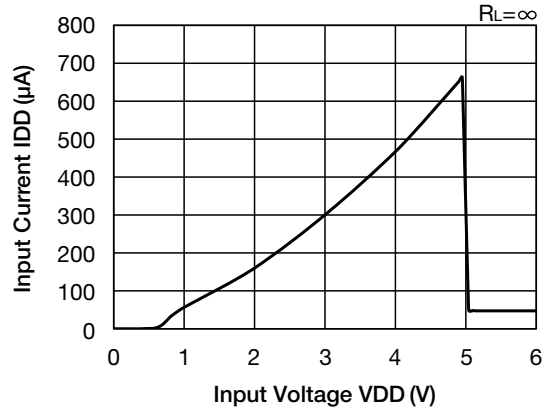

**Load Regulation**

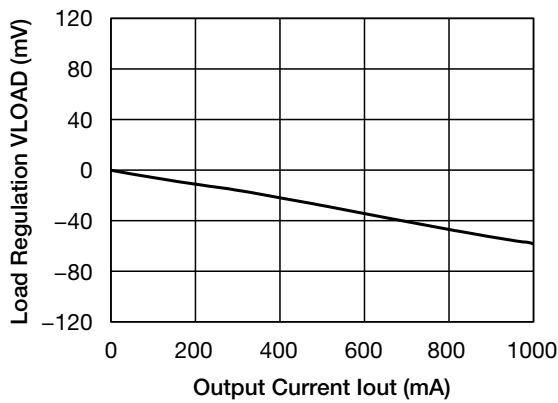

**Line Regulation**

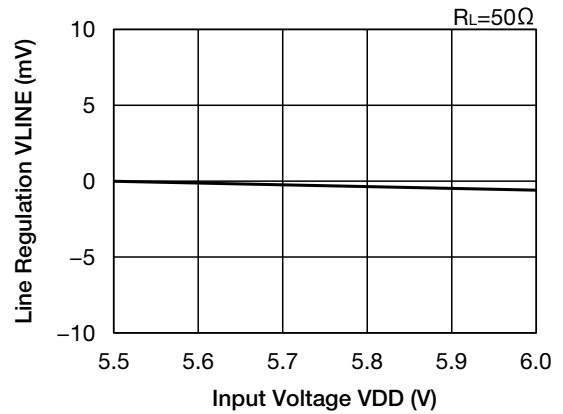

**Dropout Voltage**

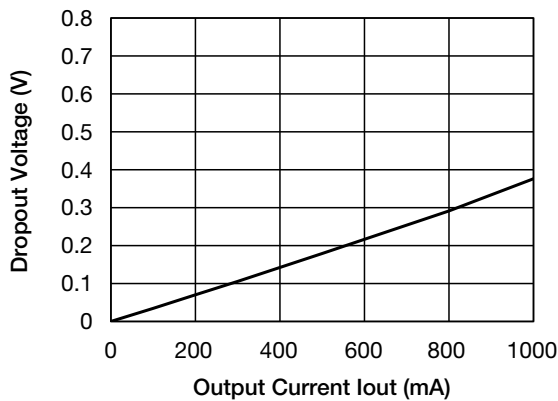

**Ripple Rejection**

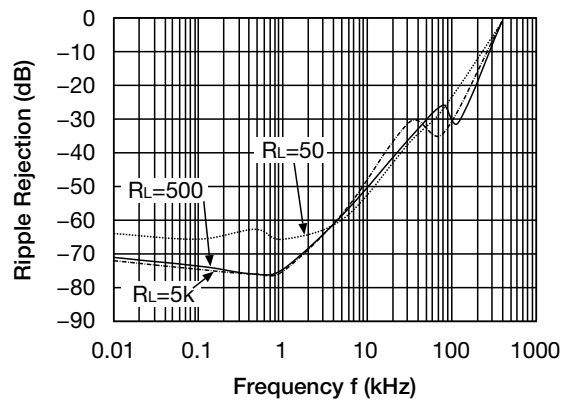

• Any products mentioned in this catalog are subject to any modification in their appearance and others for improvements without prior notification.  
 • The details listed here are not a guarantee of the individual products at the time of ordering. When using the products, you will be asked to check their specifications.

■ Output Current - Output Voltage

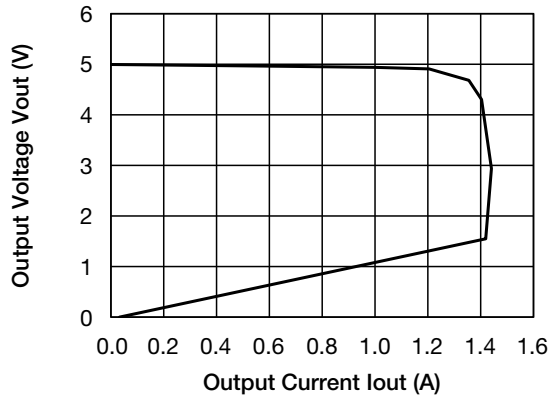

■ ESR stable area

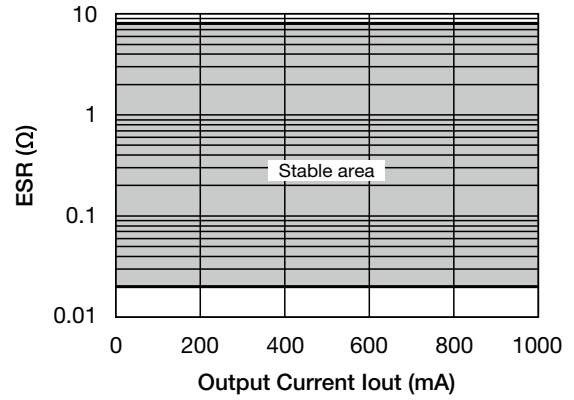

■ Output Voltage Temperature Coefficient

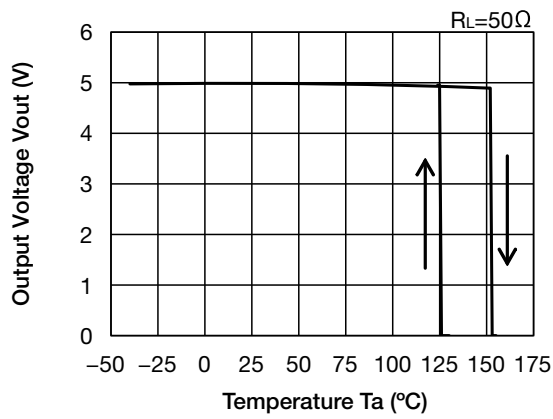

■ Load Transient response (Cin=Co=1μF)

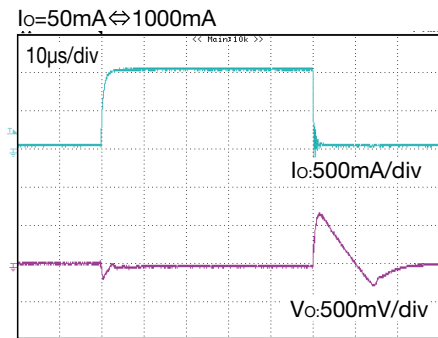
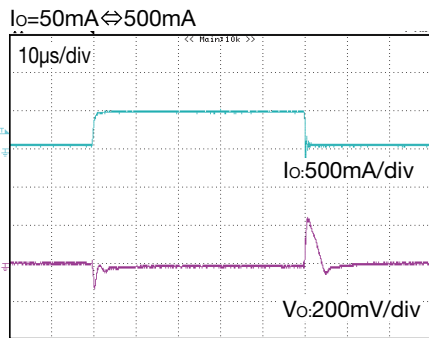

**Input rise characteristics**  
(VDD=0V↔6.0V, VCE=VDD)

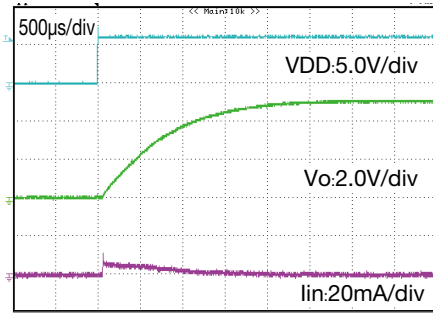

**CE rise characteristics**  
(VDD=6.0V, CE=0V↔VDD)

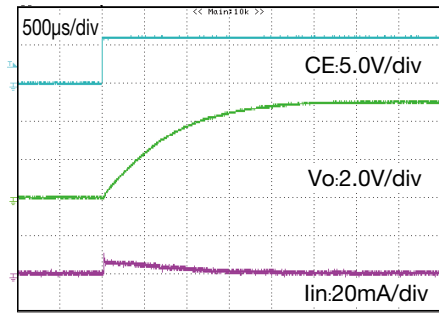

**Vout discharge characteristics**  
(VDD=6.0V, CE=VDD↔0V)

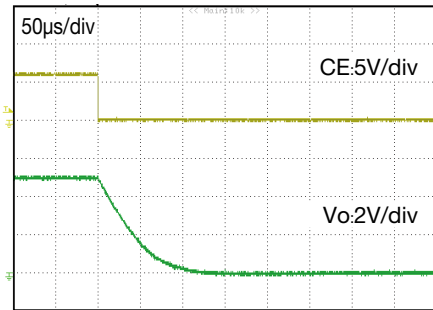

**Cs discharge characteristics**  
(VDD=6.0V, CE=VDD↔0V)

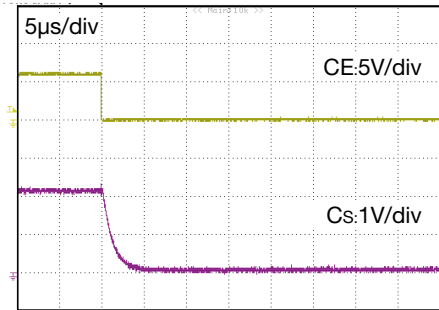

**Rush Current Peak Level**  
Co: Aluminum electrolytic capacitor

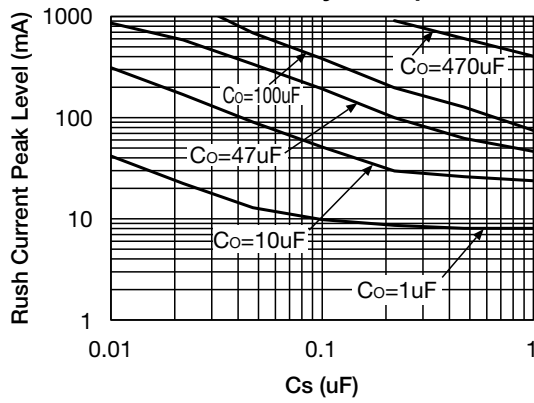

**Output rise time**

