

General Specifications

Motor Structure: Shaded Pole Induction Motor
 Motor Protection: Impedance Protection
 Insulation Resistance: 100M Ohm or over with DC500V Megger
 Dielectric Withstand Voltage: AC 1800V 3s
 Allowable Ambient Temperature Range:
 -10 degree C ~ +70 degree C (Operating)
 -40 degree C ~ +70degree C (Storage)
 (non-condensing environment)

Material

Casing: Aluminum Black Painting
 Impeller: Plastic (Black) UL94V-0
 Lead Wire or Terminal: UL3266, AWG22 / Faston #110 or equivalent

09238SB product picture



09238SB characteristics curve

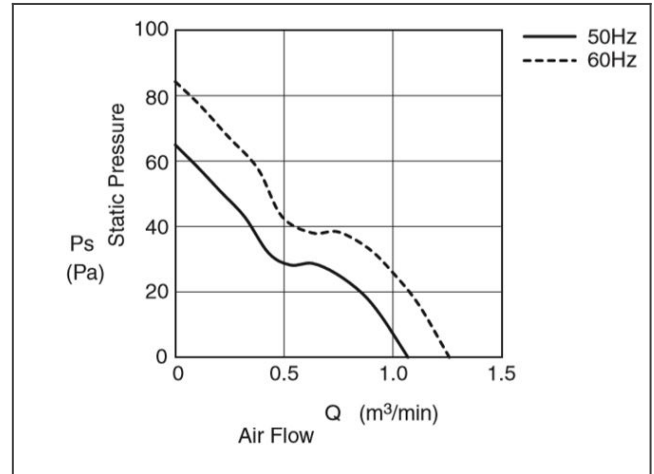

AC Fans

09238SB panel cut out

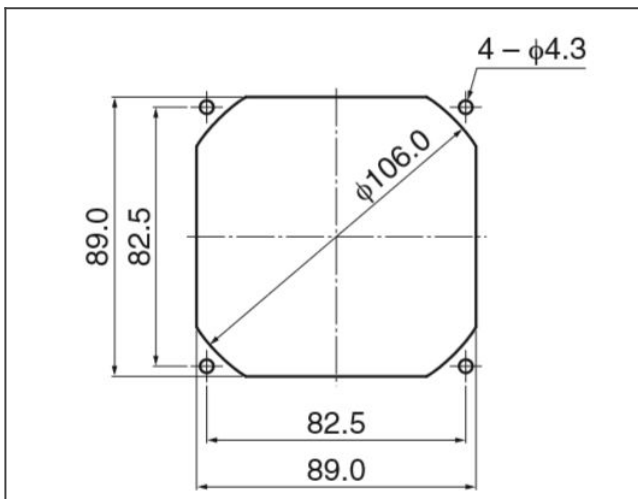

09238SB product drawing

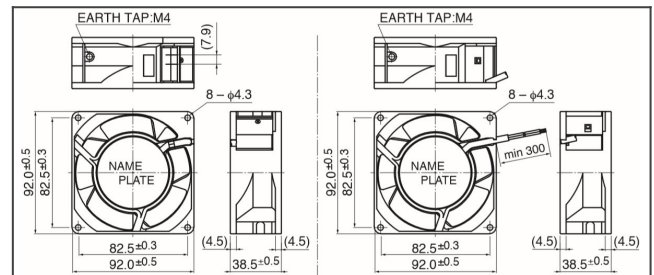

Detailed Specifications

Expected Life:	*Failure rate 10% 25deg.C 100,000 hours
Nominal Voltage:	220
Frequency:	60
Starting Voltage:	145
AC Fans:	Ball Bearing Fan
Current:	0.05
Input Power (+10% - 20%):	7
Speed:	3150
Max. Air Flow:	1.25
Max. Air Flow:	44.1
Max. Static Pressure:	80
Max. Static Pressure:	0.32
Noise:	33.5
Fan Size:	92
Fan Width:	38
Mass:	490

AC Fans