

General Specifications

Motor Structure: Shaded Pole Induction Motor
 Motor Protection: Thermal Protection
 Insulation Resistance: 10M Ohm or over with DC500V Megger
 Dielectric Withstand Voltage: AC 700V 1s
 Allowable Ambient Temperature Range:
 -10 degree C ~ +60 degree C (Operating)
 -40 degree C ~ +70 degree C (Storage)
 (non-condensing environment)

Material

Casing: Aluminum Black Painting
 Impeller: Plastic (Black) UL94V-0
 Lead Wire or Terminal: AWG22, UL3266 Faston #110 or equivalent

11938SB-A0N-NP plastic std product picture



11938SB-A0N-NP plastic std characteristic curve

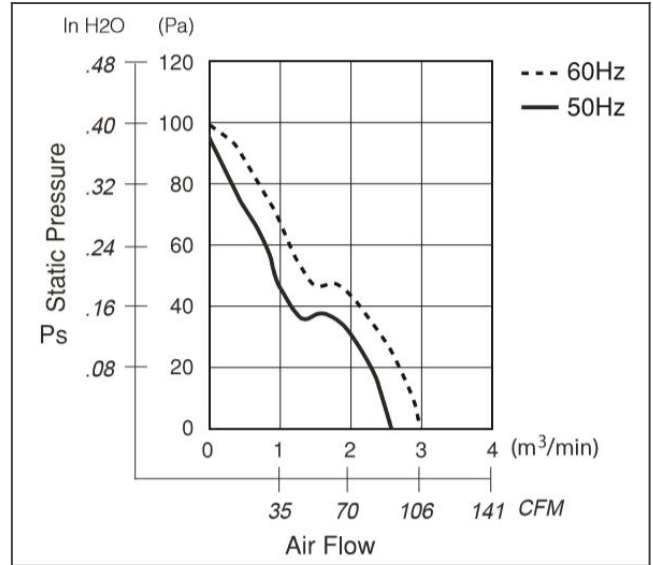

11938SB-A0N-NP plastic std product drawing

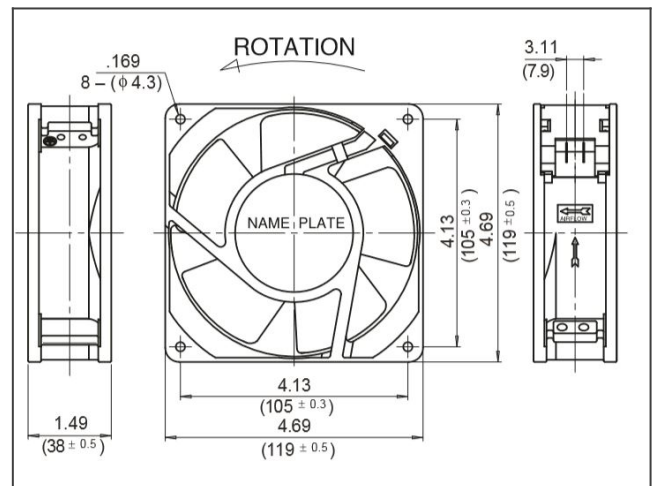

11938SB-A0N-NP plastic std panel cut out

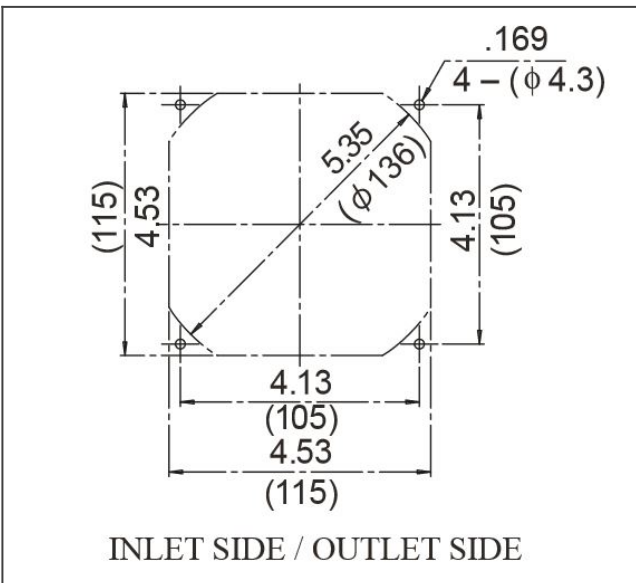

AC Fans

Detailed Specifications

Expected Life:	*Failure rate 10% 25deg.C 100,000 hours
Nominal Voltage:	100
Frequency:	50
Starting Voltage:	65
Industry:	Food Processing / Industrial Machines / Medical Equipment / Consumer Technology
AC Fans:	Ball Bearing Fan Plastic Blades Standard
Current:	0.37
Input Power (+10% - 20%):	18
Speed:	2600
Max. Air Flow:	2.6
Max. Air Flow:	92.9
Max. Static Pressure:	94
Max. Static Pressure:	0.38
Noise:	40
Fan Size:	119
Fan Width:	38
Mass:	570

AC Fans