

General Specifications

Motor Protection: Auto Restart/Polarity Protection
 Insulation Resistance: 10M Ohm or over with a DC500V Megger
 Dielectric Withstand Voltage: AC 700V 1st
 Allowable Ambient Temperature Range:
 B50 Class: -10 degree C ~ +40 degree C (Operating)
 B10 ~ B40 Class: -10 degree C ~ +70 degree C (Operating)
 B10 ~ B40 Class: -40 degree C ~ +70 degree C (Storage)
 B50 Class: -40 degree C ~ +60 degree C (Storage) (non-condensing environment)

order part 4715KL-05W-B49-P50 Ball Bearing Fan DC Fans



4715KL panel cut out

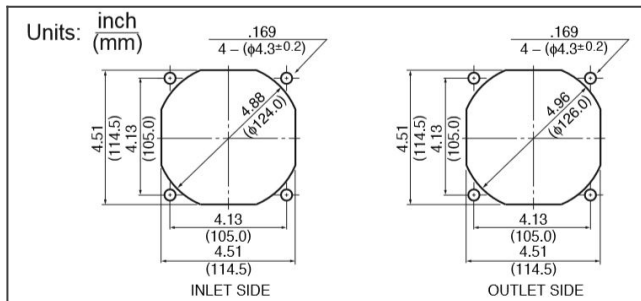

Material

Casing: Plastic (Black) UL94V-0
 Impeller: Plastic (Black) UL94V-0
 Lead Wire: UL1007, AWG24, +Red, -Black

4715KL characteristic curve

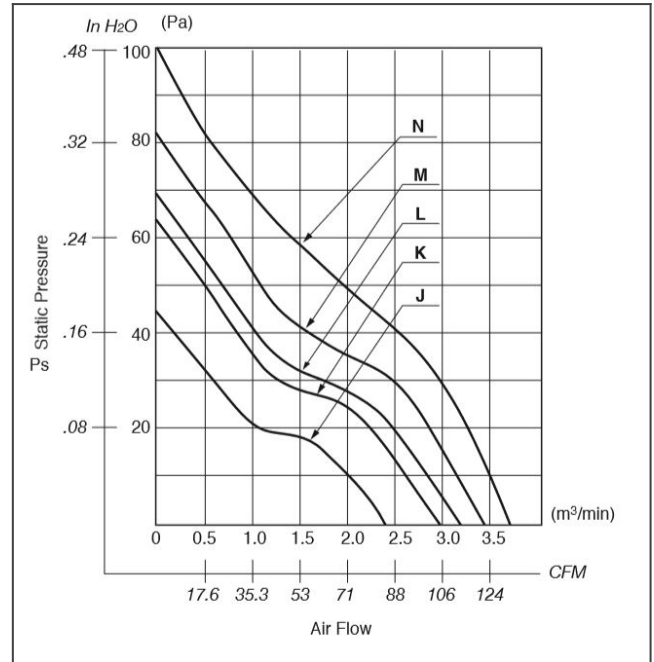

4715KL product drawing

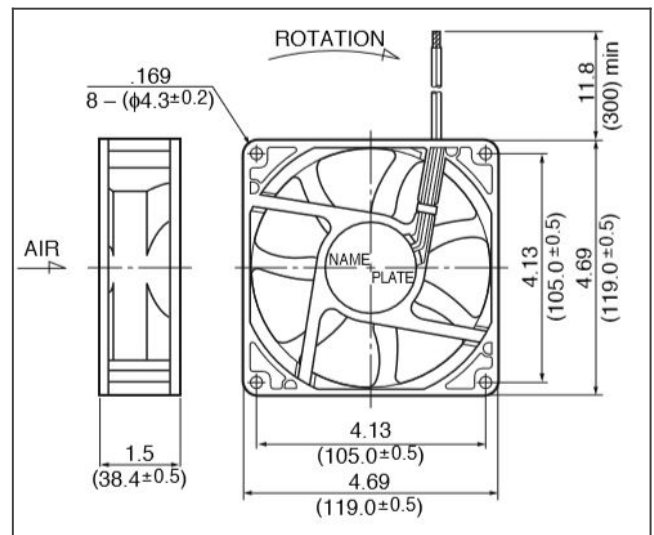

Detailed Specifications

Expected Life:	25 degree C 100,000 Hours (L10)
DC Fan:	Ball Bearing Fan
Nominal Voltage:	24[V]
Operating Voltage Lower:	10[V]
Operating Voltage Upper:	27.6[V]
Current:	0.35[A]
Input Power:	8.4[W]
Speed:	3200[min^{-1}]
Max. Air Flow:	3.34[m^3/min]
Max. Air Flow:	117.9[CFM]
Max. Static Pressure:	81.4[Pa]
Max. Static Pressure:	0.33[In H ₂ O]
Noise:	46.5[dB]
Mass:	260[g]
Fan Size:	119[mm]
Fan Width:	38[mm]
Life Expectancy L10:	25 degree C 50,000 Hours (L10)
Series:	4715KL

DC Fans